

BUCK™ CHUCK COMPANY

P R O D U C T C A T A L O G



www.buckchuck.com

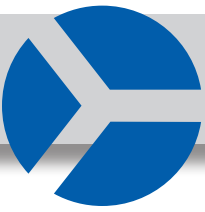

Table of Contents

Technical Information

Why a Buck?	3
Manual Chuck Selection	5
Spindle Identification for Mounting Plates.....	6
Obsolete Chuck Crossover.....	7
Parts Breakdown.....	8

ATSC Manual Steel Body Scroll Chucks --- Ajust-Tru® Style

3 and 6 Jaw - Forged Steel Body Scroll Chuck - Hardened Reversible Top Jaws	9
3 and 6 Jaw - Forged Steel Body Scroll Chuck - Hardened Solid Jaws.....	10
4 Jaw - Forged Steel Body Scroll Chuck - Hardened Reversible Top Jaws	11
3 and 6 Jaw - Forged Steel Body Scroll Chuck - 5C Adapted	11
ATSC and AT+ Scroll Chuck Mounting Plates	12
ATSC and AT+ Scroll Chuck Mounting Plates	13

AT Semi-Steel Body Scroll Chucks --- Ajust-Tru® Style

3 and 6 Jaw - Forged Steel Body Scroll Chuck - Hardened Reversible Top Jaws.....	14
AT Scroll Chuck Mounting Plates.....	15
AT Scroll Chuck Mounting Plates.....	16

IND Manual Cast Iron Body Independent Chucks

4-Jaw Independent Chucks.....	17
Independent Chuck Mounting Plates.....	18

Low Profile Manual Steel Body Stationary Chucks

3 Jaw Round Low Profile Stationary Chucks	19
4 Jaw Square Low Profile Stationary Chucks	19

Power Operated Chucks

TK Air-Operated 3-Jaw Power Chucks.....	21
MO Stationary Closed Center 3-Jaw Power Chuck	22
BPC High-Speed, Thru-Hole 3-Jaw Power Chuck	23
BBC High-Speed, Large Bore 3-Jaw Power Chuck	24
BC Super High-Speed Hollow Rotary Hydraulic Cylinders.....	25
CL High-Speed Closed Center 3-Jaw Power Chuck.....	26
Super Life 3-Jaw Stationary Power Chuck.....	27
Super Life 3-Jaw Power Chuck.....	28
Super Life 2/3-Jaw Power Chuck.....	29
Buck Pull-Back 2-Jaw Power Chuck.....	30

Buck Extra Heavy-Duty Oil Country Chucks	31
--	----

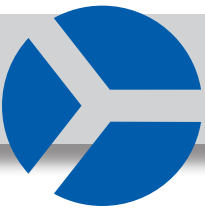

If a Chuck's a Chuck, Then Why a Buck?

Depth. In Experience. In Heritage. In Product.

How about 75 years. That's how long Buck Chuck™ Company has engineered and built some of the finest chucks in the world. Buck Chuck brings the depth of one of the world's most recognized workholding companies. Our legacy lines — the ATSC and AT Adjust-Tru® self-centering manual scroll chucks, as well as our Precision Power Chucks set new standards for quality, affordability and repeatability. **That's why a Buck.**

Service.

Buck Chuck Company has a dedicated team of customer service and sales representatives that have the technical knowledge to help make your Buck experience as hassle-free as possible. We also work closely with some of the most-recognized industrial products distributors to provide you with the proper solution to any of your chuck needs. It's a commitment we make to each and every one of our customers. **That's why a Buck.**

Price to performance.

You can buy the cheapest chuck out there and here's what you'll get. You'll get cheap. A chuck that's not as repeatable or as accurate as you need. A chuck that takes too much of your machine operator's time to adjust and true. A chuck that isn't productive. It's the cost of that lost productivity that you need to consider. But not with Buck Chuck. You'll get the most accurate and repeatable chucks on the market. **That's why a Buck.**

Parts & Accessories.

Not only does Buck Chuck Company provide the benchmark in manual chucks, we also offer power chucks and precision chucks as well. Our chucks come in a variety of sizes and styles and are ideal for replacement of OEM manual and power chucks.

That's why a Buck.

Whatever the workholding need, Buck can help. **That's why a Buck.**

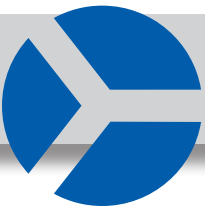

Manual Chucks

ATSC, AT and 4-Jaw Independent

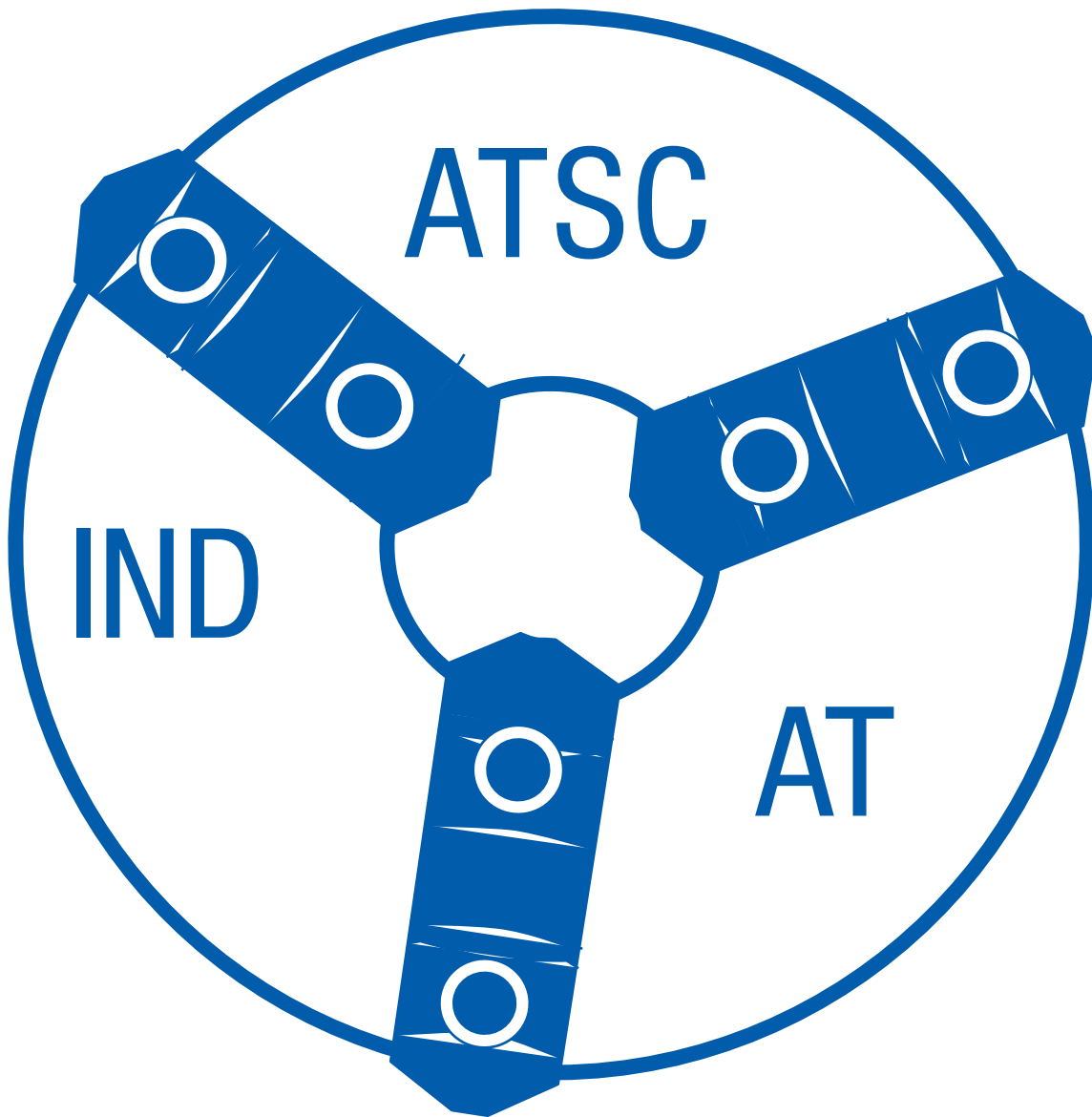



Manual Chuck Selection

ATSC, AT and 4-Jaw Independent

How do you determine what type of chuck and mounting plate is required for the application?



ATSC CHUCK APPLICATIONS:

- Precision machining
- Large quantity productions
- Higher RPM needs



AT CHUCK APPLICATIONS:

- Tool room applications
- Grinding



4-JAW INDEPENDENT CHUCK APPLICATIONS:

- Tool room applications
- Grinding
- Odd-shaped parts

What size of chuck?

- Do not exceed the swing of the diameter over the cross slide. Make sure the part will fit safely and securely within the envelope.

What accuracy and repeatability is required?

- High precision – the ATSC chucks provide .0005 TIR on duplicate parts
- General I.D. or O.D. work – the AT chucks provide .001 TIR on duplicate parts

How many jaws are required?

- 2-Jaw – special applications, can be used as a vice, ideal for squares, elbows, T's or other oddly shaped parts
- 3-Jaw – conventional machining, best choice for bar stock, rough castings, or any other parts with small irregularities
- 4-Jaw – square and offset work, can be used as a 2 jaw by removing two opposing jaws
- 6-Jaw – 2nd operation or thin wall parts, can be used as a 2 or 3 jaw chuck by removing jaws

What type of jaw is needed?

- The most common are the reversible top jaws. These can be used for both I.D. or O.D. work and production work
- 2-piece jaw chucks can be adapted to soft jaws or special top tooling
- Solid jaws are typically used for tool room applications, and due to elimination of top jaw mounting error, are ideal for second operation machining

What mounting is needed?

- Determine spindle type using the spindle identifier on page 6
- Measure the major diameter of the taper and match to the chart for the spindle type on page 6
- For threaded spindles, you will need to measure threads per inch

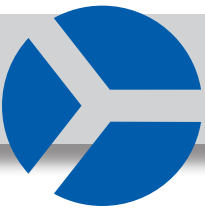

Spindle Identification for Mounting Plates

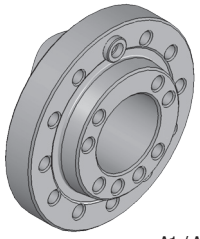

A1 / A2

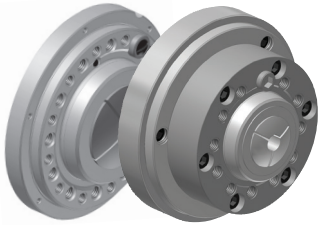
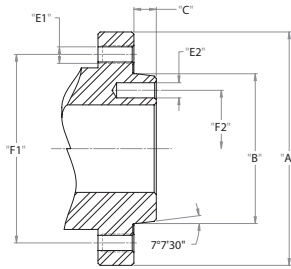

5C COLLET-READY

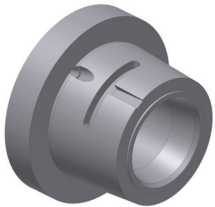
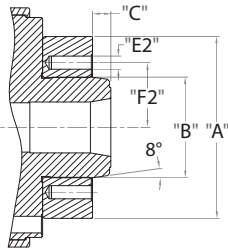

HARDINGE
4-DEGREE

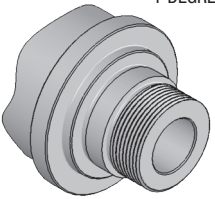
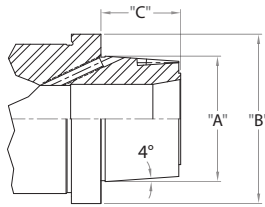

THREADED

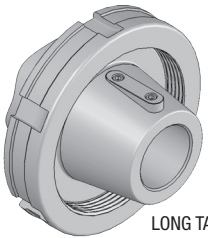
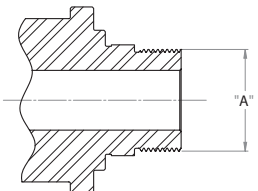

LONG TAPER

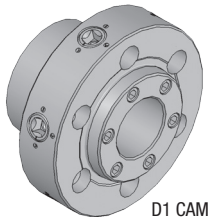
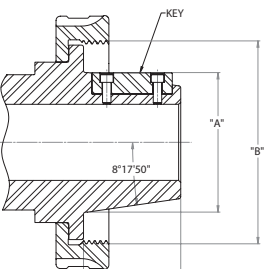

D1 CAMLOCK

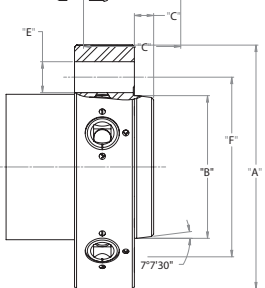

SPINDLE TYPE A1 & A2

Spindle nose	A	B	C (MAX)	E1 & E2	F1	F2
A-4	4 1/4"	2.500	0.437	7/16"-14	3.250	-----
A-5	5 1/4"	3.251	0.563	7/16"-14	4.125	2.437
A-6	6 1/2"	4.188	0.625	1/2"-13	5.250	3.250
A-8	8 1/4"	5.501	0.688	5/8"-11	6.750	4.375
A-11	11"	7.751	0.750	3/4"-10	9.250	6.500
A-15	15"	11.251	0.813	7/8"-9	13.000	9.750
A-20	20 1/2"	16.251	0.875	1"-8	18.250	14.500
A-28	28 1/2"	23.001	1.000	1-1/4"-7	25.500	10.438

5C COLLET-READY

Spindle nose	A	B	C (MAX)	E2	F2
A-4	4.560"	2.500	0.460	M10-1.5x.75	1.625
A-5	5.500"	3.251	0.500	M10-1.5x.76	2.0625
A-5	—	3.251	0.500	M10-1.5x.75	2.0625
A-6	—	4.192	0.562	M12-1.75x.88	2.6250

HARDINGE 4 DEGREE SPINDLE

Spindle nose	A	B	C (MAX)
4-Degree	2.316	3.126	1.472

THREADED SPINDLE TYPE

Spindle nose thread
A
1"-8
1"-10
1 1/2"-8
1 3/4"-8
2 1/4"-8
2 3/8"-6
2 3/4"-8
2 3/16"-10

L SPINDLE TYPE LONG TAPER KEY DRIVE

Spindle nose	A	Thread B	C	KEY
L00	3 1/2"	3-3/4"-6	2.000	3/8 x 3/8 x 1-1/2
L0	4 1/8"	4-1/2"-6	2.375	3/8 x 3/8 x 1-3/4
L1	5 3/4"	6"-6	2.875	5/8 x 5/8 x 2-3/8
L2	7 3/8"	7-3/4"-5	3.375	3/4 x 3/4 x 2-7/8
L3	10"	10-3/8"-4	3.875	1.00 x 1.00 x 3-1/4

D1 CAMLOCK SPINDLE TYPE

Spindle nose	A	B	C (MAX)	CAMSTUD DIA "E"	F
D1-3	3 5/8"	2.125	0.437	9/16	2.782
D1-4	4 1/4"	2.500	0.437	5/8	3.250
D1-5	5 3/4"	3.251	0.500	3/4	4.125
D1-6	7 1/8"	4.188	0.625	7/8	5.250
D1-8	8 7/8"	5.501	0.688	1	6.750
D1-11	11 3/4"	7.751	0.750	1-3/16	9.250
D1-15	15 7/8"	11.251	0.813	1-3/8	13.000

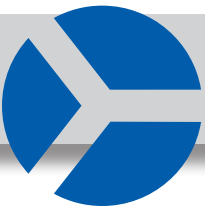

Obsolete Chuck Crossover

AT+ MODELS - SOLID & 2 PIECE JAW			
Obsolete Model #	Obsolete Part #	Model #	Direct Replacement Part #
3AT+4	A100176977	3ATSC04S	B8043S
6AT+4	A100211977	6ATSC04S	B8046S
3AT+5	A100177977	3ATSC05S	B8053S
6AT+5	A100212977	6ATSC05S	B8056S
3AT+6	A100178977	3ATSC06S	B8063S
6AT+6	A100213977	6ATSC06S	B8066S
3AT+6R	A100178978	3ATSC06	B8063
6AT+6R	A100213978	6ATSC06	B8066
3AT+8	A100179977	3ATSC08S	B8083S
6AT+8	A100214977	6ATSC08S	B8086S
3AT+8R	A100179978	3ATSC08	B8083
6AT+8R	A100214978	6ATSC08	B8086
3AT+10	A100180977	3ATSC10S	B8103S
6AT+10	A100215977	6ATSC10S	B8106S
3AT+10R	A100180978	3ATSC10	B8103
6AT+10R	A100215978	6ATSC10	B8106
3AT+12	A100181977	3ATSC12S	B8123S
6AT+12	A100216977	6ATSC12S	B8126S
3AT+12R	A100181978	3ATSC12	B8123
6AT+12R	A100216978	6ATSC12	B8126
3AT+15R	A100182978	3ATSC15	B8153
6AT+15R	A100217978	6ATSC15	B8156
3AT+20R	A100225903	3ATSC20	B8203

Internal components not interchangeable between obsolete and replacement models.

AT+ MODEL CHUCKS

The chart above refers to the replacement options for the obsolete AT+ model of chucks. The ATSC was designed as a replacement for this chuck – the components are not interchangeable but the ATSC can be mounted to the existing adapter plate from your AT+ chuck.

AT TWO PIECE JAW MODELS				
Obsolete AT Model #	Obsolete AT Serial #	Obsolete AT Part #	Obsolete BVC Part #	Direct Replacement Part #
3AT6R	A0002063002	2063R	B2063R	AT063RC
6AT6R	A0002066002	2066R	B2066R	AT066RC
3AT8R	A0002083002	2083R	B2083R	AT083RC
6AT8R	A0002086002	2086R	B2086R	AT086RC
3AT10R	A0002103002	2103R	B2103R	AT103RC
6AT10R	A0002106002	2106R	B2106R	AT106RC
3AT12R	A0002124002	2124R	B2124R	AT123RC
6AT12R	A0002127002	2127R	B2127R	AT126RC
3AT15R	A0002154002	2154R	B2154R	B8153**
6AT15R	A0002157002	2157R	B2157R	B8156**

**There is no direct replacement, a new chuck adapter will be needed

AT TWO PIECE JAW MODELS				
Replacement Options				
Obsolete AT Model #	Obsolete AT Serial #	Obsolete AT Part #	2 Piece Jaws Use Existing Adapter	Solid Jaws Require New Adapter
3AT4	A1434	1434	N/A	B8043S
6AT4	A1462	1462	N/A	B8046S
3AT5	A2535	2535	N/A	B8053S
6AT5	A2562	2562	N/A	B8056S
3AT6	A0002063003	3634	AT063RC	B8063S
6AT6	A0002063003	3662	AT066RC	B8066S
3AT8	A0002083003	4831	AT083RC	B8083S
6AT8	A0002086003	4862	AT086RC	B8086S
3AT10	A0002103003	5103	AT103RC	B8103S
6AT10	A0002106003	5106	AT106RC	B8106S
3AT12	A0002124003	5124	AT123RC	B8123S
6AT12	A0002127003	5127	AT126RC	B8126S

AT MODEL CHUCKS

The chart above refers to the replacement options for the obsolete AT and BVC model of chucks. The new model of the AT was designed as a replacement for this chuck – the components are not interchangeable, but it can be mounted to the existing adapter plate from your obsolete AT chuck.

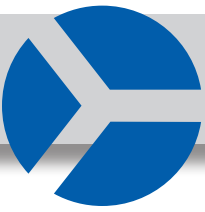

Parts Breakdown

For ATSC and AT Model Scroll Chucks

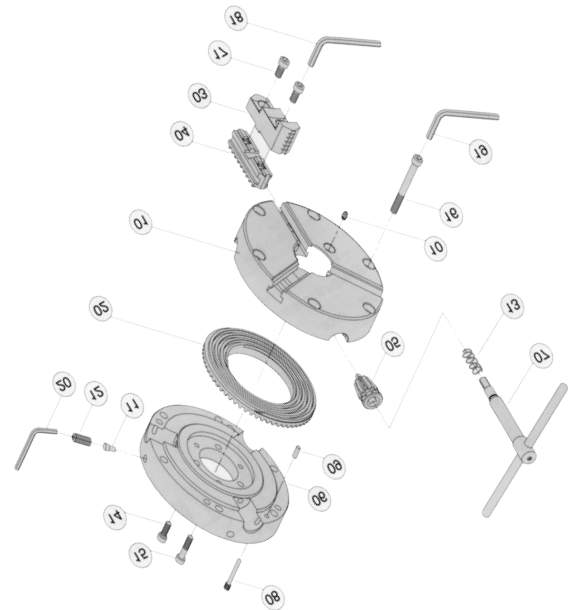
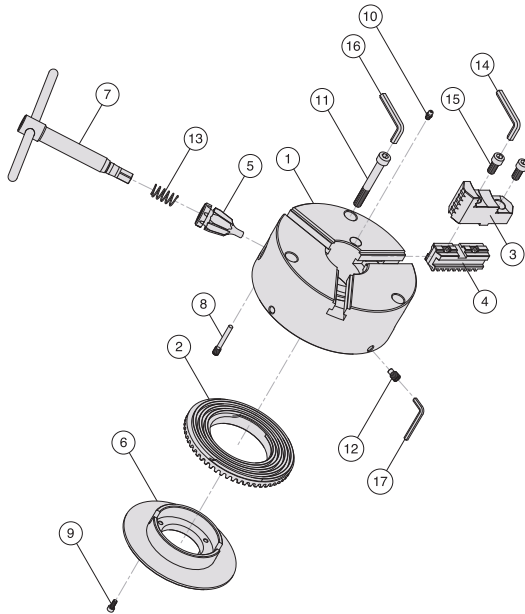

ATSC	
No.	Part Description
1	Chuck Body
2	Scroll Plate
3	Top Jaw
4	Master Jaw
5	Pinion
6	Back Cover
7	Chuck Wrench
8	Stud Bolt
9	Hexagon Socket Head Cap Screw
10	Grease Nipple
11	Chuck Mounting Bolt
12	Adjust Screw
13	Safety Spring
14	Hex Wrench
15	Jaw Mounting Bolt
16	Hex Wrench
17	Hex Wrench

AT	
No.	Part Description
1	Chuck Body
2	Scroll
3	Top Jaw
4	Master Jaw
5	Pinion
6	Back Cover
7	Chuck Wrench
8	Stud Bolt
9	Hollow Pin
10	Grease Nipple
11	Dowel Pin
12	Adjust Screw
13	Safety Spring
14	Hexagon Socket Head Cap Screw
15	Hexagon Socket Head Cap Screw
16	Chuck Mounting Bolt
17	Jaw Mounting Bolt
18	Hex Wrench
19	Hex Wrench
20	Hex Wrench

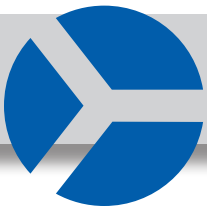

ATSC Forged Steel Body Scroll Chuck

Hardened Reversible Top Jaws

FEATURES & BENEFITS:

- 4 micro-fine adjustment screws allow .0005" TIR repeatability
- High-quality forged steel body construction allows for higher lathe speeds
- Hardened and ground scroll is precision balanced, allowing longer life and greater accuracy
- Hardened jaws and pinions increase life of the chuck
- American standard tongue and groove master jaws allow for greater flexibility in choice of top tooling

CHUCK SHIPS COMPLETE WITH:

- Master and hardened top reversible jaws
- Spring loaded T-wrench
- Allen wrench
- Mounting bolts

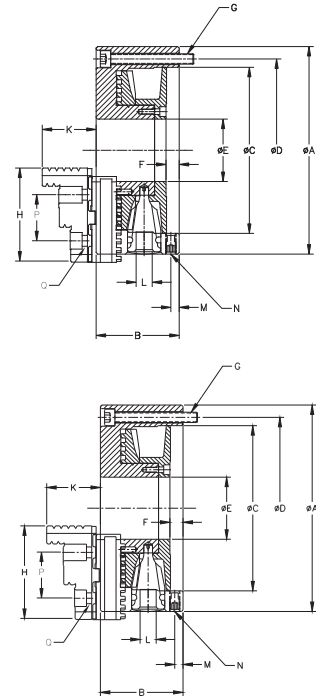
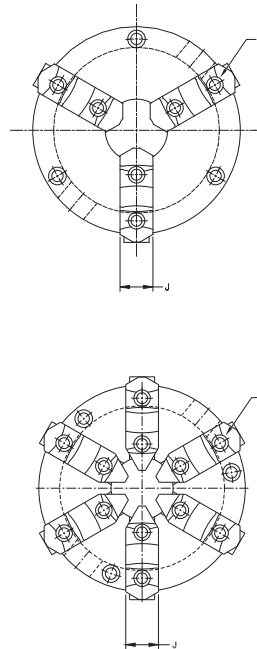

3-JAW

ATSC W/MASTER & HARDENED TOP REVERSIBLE JAWS

Dia.	Part No.	A	B	C	D	E	F	G	H	J	K	L	M	N	P	Q	Gripping Dia. (in.)		Max RPM	Wt. Lb.
																	EXT.	INT.		
*6"	B8063	6.50	2.76	4.92	5.51	1.78	0.48	M10x1.5P	2.58	1.00	1.54	23/64	0.31	M10x1.5P	1.69	5/16	0.31-5.51	2.17-5.91	4600	23
8"	B8083	7.87	3.15	6.30	6.93	2.37	0.48	M10x1.5P	3.57	1.25	2.05	7/16	0.31	M10x1.5P	1.75	3/8	0.39-7.87	2.17-7.09	4000	37
10"	B8103	10.04	3.58	7.87	8.82	3.23	0.50	M12x1.75P	3.75	1.50	2.59	31/64	0.31	M10x1.5P	2.13	1/2	0.47-9.45	3.35-8.86	3000	69
12"	B8123	12.60	3.90	10.24	11.26	4.14	0.58	M16x2P	4.41	1.75	2.57	9/16	0.35	M12x1.75P	2.50	1/2	0.71-11.22	4.92-11.22	2300	110
15"	B8153	15.74	4.96	12.99	14.25	5.51	0.59	M16x2P	5.55	2.50	3.61	2/3	0.35	M12x1.75P	3.00	3/4	0.79-14.17	5.12-14.17	1800	246
20"	B8203	19.69	5.63	16.54	18.03	7.48	0.59	M16x2P	5.55	2.50	3.61	3/4	0.35	M12x1.75P	3.00	3/4	1.57-19.69	5.12-19.69	1300	387

*6" chuck jaws are not ANSI standard – please contact us for details. Measurements in inches unless otherwise indicated.

6-JAW

ATSC W/MASTER & HARDENED TOP REVERSIBLE JAWS

Dia.	Part No.	A	B	C	D	E	F	G	H	J	K	L	M	N	P	Q	Gripping Dia. (in.)		Max RPM	Wt. Lb.
																	EXT.	INT.		
*6"	B8066	6.50	2.76	4.92	5.51	1.78	0.48	M10x1.5P	2.58	1.00	1.54	23/64	0.31	M10x1.5P	1.69	5/16	0.98-5.51	2.95-5.91	3450	23
8"	B8086	7.87	3.15	6.30	6.93	2.37	0.48	M10x1.5P	3.57	1.25	2.05	7/16	0.31	M10x1.5P	1.75	3/8	0.79-7.87	2.56-7.09	3000	40
10"	B8106	10.04	3.58	7.87	8.82	3.23	0.50	M12x1.75P	3.75	1.50	2.59	31/64	0.31	M10x1.5P	2.13	1/2	0.98-9.45	3.54-8.86	2250	73
12"	B8126	12.60	3.90	10.24	11.26	4.14	0.58	M16x2P	4.41	1.75	2.57	9/16	0.35	M12x1.75P	2.50	1/2	1.57-11.22	4.53-11.22	1725	117
15"	B8156	15.75	4.96	12.99	14.25	5.51	0.59	M16x2P	5.55	2.50	3.61	2/3	0.35	M12x1.75P	3.00	3/4	1.57-14.17	5.12-14.17	1350	253



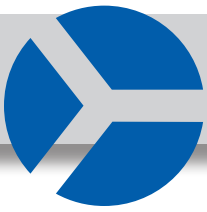

ATSC Forged Steel Body Scroll Chuck

Hardened Solid Jaws

FEATURES & BENEFITS:

- 4 micro-fine adjustment screws allow .0005" TIR repeatability
- High-quality forged steel body construction allows for higher lathe speeds
- Hardened and ground scroll is precision balanced, allowing longer life and greater accuracy
- Hardened jaws and pinions increase life of the chuck
- Hardened solid jaws allow for smaller gripping ranges as opposed to 2-piece jaw chucks

CHUCK SHIPS COMPLETE WITH:

- Inside and outside gripping solid jaws
- Spring loaded T-wrench
- Allen wrench
- Mounting bolts

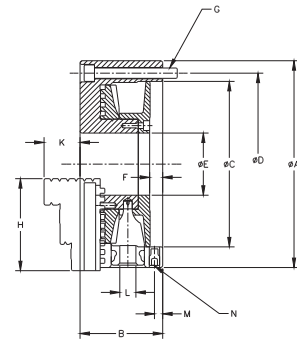
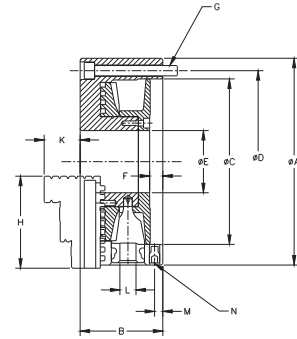
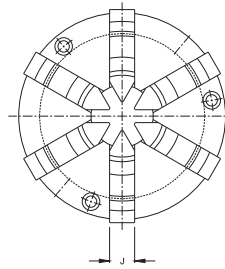
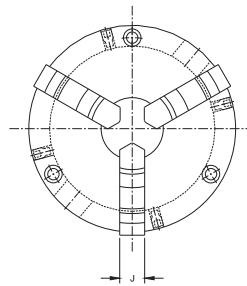

3-JAW

ATSC W/INSIDE & OUTSIDE SOLID JAWS

Dia.	Part No.	A	B	C	D	E	F	G	H	J	K	L	M	N	Gripping Dia. (in.)		Max RPM	Wt. Lb.
															EXT.	INT.		
4"	B8043S	4.07	2.38	2.80	3.53	1.04	0.42	M5x0.8P	1.62	0.44	0.75	1/4	0.24	M8x1.25P	0.08-2.76	0.98-2.95	6300	9
5"	B8053S	5.20	2.54	3.74	4.25	1.28	0.41	M8x1.25P	1.88	0.63	0.80	5/16	0.26	M8x1.25P	0.08-3.54	1.42-3.74	5500	13
6"	B8063S	6.50	2.76	4.92	5.51	1.78	0.48	M10x1.5P	2.52	0.74	0.96	23/64	0.31	M10x1.5P	0.12-5.51	2.05-5.71	4600	23
8"	B8083S	7.87	3.15	6.30	6.93	2.37	0.48	M10x1.5P	3.50	0.95	1.37	7/16	0.31	M10x1.5P	0.16-6.30	2.36-6.69	4000	39
10"	B8103S	10.04	3.58	7.87	8.82	3.23	0.50	M12x1.75P	3.62	1.23	1.83	31/64	0.31	M10x1.5P	0.24-8.27	2.95-8.66	3000	72
12"	B8123S	12.60	3.90	10.24	11.26	4.14	0.58	M16x2P	4.25	1.48	1.75	9/16	0.35	M12x1.75P	0.39-10.04	3.35-9.94	2300	115

6-JAW

ATSC W/INSIDE & OUTSIDE SOLID JAWS

Dia.	Part No.	A	B	C	D	E	F	G	H	J	K	L	M	N	Gripping Dia. (in.)		Max RPM	Wt. Lb.
															EXT.	INT.		
4"	B8046S	4.07	2.36	2.80	3.53	1.04	0.42	M5x0.8P	1.62	0.41	0.75	1/4	0.24	M8x1.25P	0.08-2.76	0.98-2.95	4725	9
5"	B8056S	5.20	2.54	3.80	4.25	1.28	0.41	M8x1.25P	1.88	0.63	0.80	5/16	0.26	M8x1.25P	0.08-3.54	1.42-3.74	4125	14
6"	B8066S	6.50	2.76	4.92	5.51	1.78	0.48	M10x1.5P	2.52	0.74	0.96	23/64	0.31	M10x1.5P	0.24-5.51	2.36-5.71	3450	25
8"	B8086S	7.87	3.15	6.30	6.93	2.37	0.48	M10x1.5P	3.50	0.95	1.37	7/16	0.31	M10x1.5P	0.39-6.30	2.76-6.69	3000	44
10"	B8106S	10.04	3.58	7.87	8.82	3.23	0.50	M12x1.75P	3.62	1.23	1.83	31/64	0.31	M10x1.5P	0.59-8.27	2.76-8.66	2600	80
12"	B8126S	12.60	3.90	10.24	11.26	4.14	0.58	M16x2P	4.25	1.48	1.75	9/16	0.35	M12x1.75P	0.79-10.04	3.35-9.94	1725	117

Measurements in inches unless otherwise indicated.



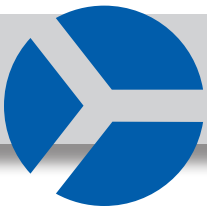

ATSC Forged Steel Body Scroll Chuck

Hardened Reversible Top Jaws

FEATURES & BENEFITS:

- 4 micro-fine adjustment screws allow .0005" TIR repeatability
- High-quality forged steel body construction allows for higher lathe speeds
- Hardened and ground scroll is precision balanced, allowing longer life and greater accuracy
- Hardened jaws and pinions increase life of the chuck
- American standard tongue & groove master jaws allow for greater flexibility in choice of top tooling

CHUCK SHIPS COMPLETE WITH:

- Master and hardened top reversible jaws
- Spring loaded T-wrench
- Allen wrench
- Mounting bolts

**Please note that this is a SCROLL chuck. All jaws move together, NOT independently (if you need an independent chuck, see page 15).

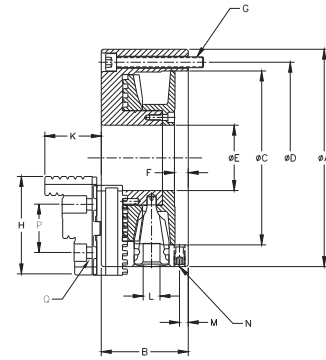
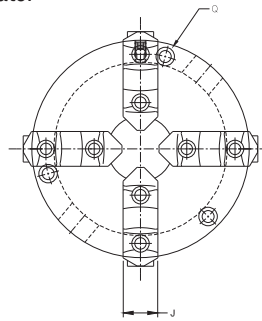

4-JAW

ATSC W/MASTER & HARDENED TOP REVERSIBLE JAWS

Dia.	Part No.	A	B	C	D	E	F	G	H	J	K	L	M	N	P	Q	Gripping Dia. (in.)		Max RPM	Wt. Lb.
																	EXT.	INT.		
6"*	B8064	6.50	2.76	4.92	5.51	1.78	0.48	M10x1.5P	2.58	1.00	1.54	23/64	0.31	M10x1.5P	1.69	5/16	0.31-5.51	2.17-5.91	4600	23
8"	B8084	7.87	3.15	6.30	6.93	2.37	0.48	M10x1.5P	3.57	1.25	2.05	7/16	0.31	M10x1.5P	1.75	3/8	0.39-7.87	2.17-7.09	4000	38
10"	B8104	10.04	3.58	7.87	8.82	3.23	0.50	M12x1.75P	3.75	1.50	2.59	31/64	0.31	M10x1.5P	2.13	1/2	0.47-9.45	3.35-8.86	3000	71
12"	B8124	12.60	3.90	10.24	11.26	4.14	0.58	M16x2P	4.41	1.75	2.57	9/16	0.35	M12x1.75P	2.50	3/4	0.71-11.22	4.92-11.22	2300	130

*6" Chuck Jaws are Not ANSI Standard, 6" Chuck has a 4 Bolt Pattern instead of 3



FEATURES & BENEFITS:

- 4 micro-fine adjustment screws allow .0005" TIR repeatability
- High-quality forged steel body construction allows for higher lathe speeds
- Hardened and ground scroll is precision balanced, allowing longer life and greater accuracy
- Hardened jaws and pinions increase life of the chuck
- Used in tail stocks for jobs where centers cannot be used
- Adapter does not rotate

3/6-JAW

5C ADAPTED AJUST-TRU® CHUCKS

Part #	Jaw Style	Chuck Dia. (in.)	Chuck Body Height (in.)	Shank	Flange (in.)	Adapter Hole Dia (in.)	Adapter Length (in.)	Thread
B8043S-5C	Solid 3-Jaw	4.07	2.38	5C	4	0.866	4.41	1 1/4-20
B8053S-5C	Solid 3-Jaw	5.20	2.54	5C	5	0.866	4.41	1 1/4-20
B8063S-5C	Solid 3-Jaw	6.50	2.76	5C	6	0.866	4.41	1 1/4-20
B8046S-5C	Solid 6 -Jaw	4.07	2.38	5C	4	0.866	4.41	1 1/4-20
B8056S-5C	Solid 6-Jaw	5.20	2.54	5C	5	0.866	4.41	1 1/4-20
B8066S-5C	Solid 6-Jaw	6.50	2.76	5C	6	0.866	4.41	1 1/4-20
*B8063-5C	2 pc 3-Jaw	6.50	2.76	5C	6	0.866	4.41	1 1/4-20
*B8066-5C	2 pc 6-Jaw	6.50	2.76	5C	6	0.866	4.41	1 1/4-20
*B8064-5C	2 pc 6-Jaw	6.50	2.76	5C	6	0.866	4.41	1 1/4-20

CHUCK SHIPS COMPLETE WITH:

- Jaws
- 5C adapter
- Spring loaded T-wrench
- Allen wrench
- Mounting bolts

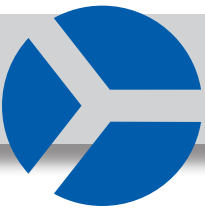

ATSC and AT+ Scroll Chuck Mounting Plates

Adapt to all 3, 6 and 4-Jaw ATSC and AT+ Models

Buck Chuck can also custom design adapter plates. If you do not see your spindle or mounting surface indicated here, please contact our sales office for assistance.

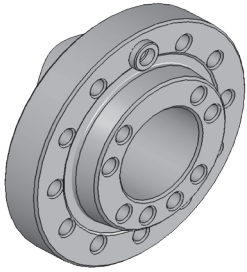

AMERICAN STANDARD • STYLE A1 & A2								
Spindle Size	Chuck Size							
	4	5	6	8	10	12	15	20
3	A4-A3	A5-A3	A6-A3	-	-	-	-	-
4	-	A5-A4	A6-A4	A8-A4	-	-	-	-
5	-	-	A6-A5	A8-A5	A10-A5	-	-	-
6	-	-	A6-A6	A8-A6	A10-A6	A12-A6	-	-
8	-	-	A6-A8	A8-A8	A10-A8	A12-A8	A15-A8	A20-A8
11	-	-	-	-	-	A12-A11	A15-A11	A20-A11
15	-	-	-	-	-	-	-	A20-A15

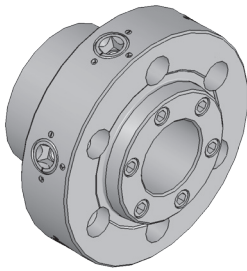

AMERICAN STANDARD • STYLE D1 CAMLOCK								
Spindle Size	Chuck Size							
	4	5	6	8	10	12	15	20
3	A4-D3	A5-D3	A6-D3	-	-	-	-	-
4	-	A5-D4	A6-D4	A8-D4	-	-	-	-
5	-	-	A6-D5	A8-D5	A10-D5	-	-	-
6	-	-	A6-D6	A8-D6	A10-D6	A12-D6	-	-
8	-	-	A6-D8	A8-D8	A10-D8	A12-D8	A15-D8	-
11	-	-	-	-	-	A12-D11	A15-D11	A20-D11
15	-	-	-	-	-	-	-	A20-D15

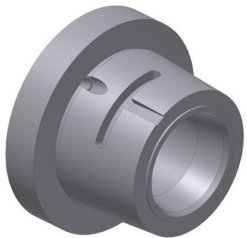

HARDINGE 4-DEGREE TAPER MOUNTING PLATES		
Chuck Size	5	6
Id #	A5-4DEG	A6-4DEG

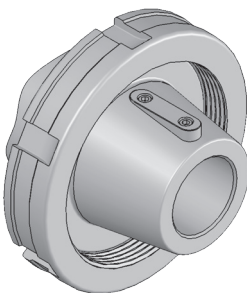

AMERICAN STANDARD • LONG TAPER STYLE L						
Spindle Size	Chuck Size					
	6	8	10	12	15	20
L-00	A6-L00	A8-L00	A10-L00	-	-	-
L-0	A6-L0	A8-L0	A10-L0	A12-L0	-	-
L-1	-	A8-L1	A10-L1	A12-L1	A15-L1	A20-L1
L-2	-	-	-	A12-L2	A15-L2	A20-L2
L-3	-	-	-	-	A15-L3	A20-L3

See Spindle Identification on page 6 to determine the correct mounting plate needed.

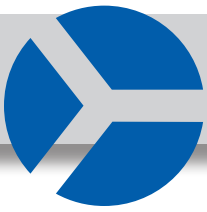

ATSC Scroll Chuck Mounting Plates

Adapt to all 3, 6 & 4-Jaw ATSC Models

Buck Chuck can also custom design adapter plates. If you do not see your spindle or mounting surface indicated here, please contact our sales office for assistance.

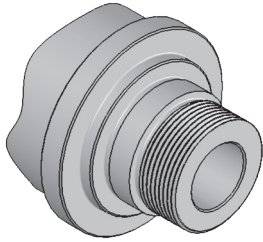

THREADED MOUNTING PLATES						
Spindle Size	Chuck Size					
	4	5	6	8	10	12
1-1/2"-8	A100433000	A100434000	A100435000	–	–	–
1-3/4"-8	–	A100437000	A100438000	–	–	–
2-1/4"-8	–	–	A100439000	A100440000	A100441000	–
2-3/16"-10	–	A100451000	A100452000	–	–	–

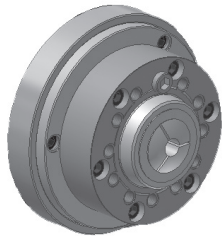

5C MOUNTING PLATES						
Chuck Size	Part No.	Shank	Flange	Hole Dia.	Length	Thread
4	A04-5C	5C	4"	0.866	4.41	1 1/4-20
5	A05-5C	5C	5"	0.866	4.41	1 1/4-20
6	A06-5C	5C	6"	0.866	4.41	1 1/4-20

Measurements in inches unless otherwise indicated.

See Spindle Identification on page 6 to determine the correct mounting plate needed.

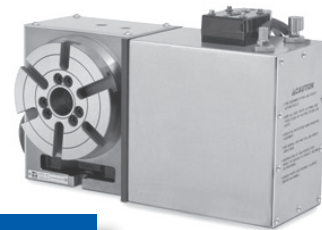

HRT ROTARY TABLE PLATES		
Spindle	Chuck Size	Part Number
HRT110	4"	A4-HRT110
HRT160	6"	A6-HRT160
HRT210	8"	A8-HRT210
HRT310	10"	A10-HRT310

Adapters available for other Rotary Table models. Please contact our sales office.

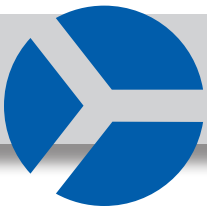

AT Semi-Steel Manual Scroll Chuck

Hardened Reversible Top Jaws

FEATURES & BENEFITS:

- .001" repeatability on duplicate parts due to .020" of clearance between the chuck cavity and mounting plate hub
- Cast iron body allows for a more affordable but high quality chuck
- Hardened and ground scroll is balanced for higher accuracy
- Jaws are hardened and ground for longer life

CHUCK SHIPS COMPLETE WITH:

- Master and hardened top reversible jaws
- Spring loaded T-wrench
- Mounting bolts

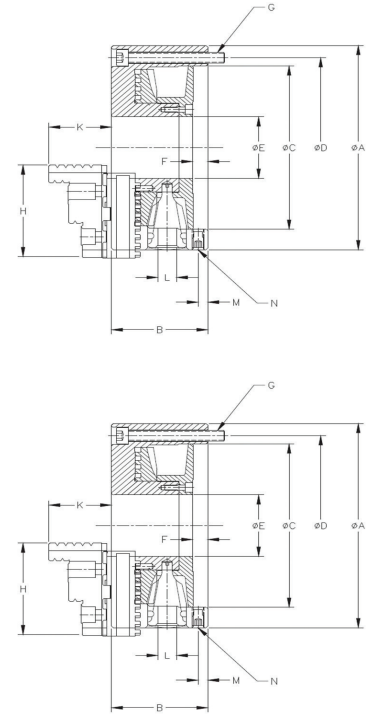
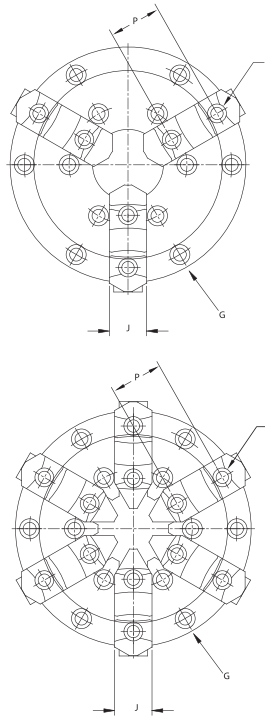
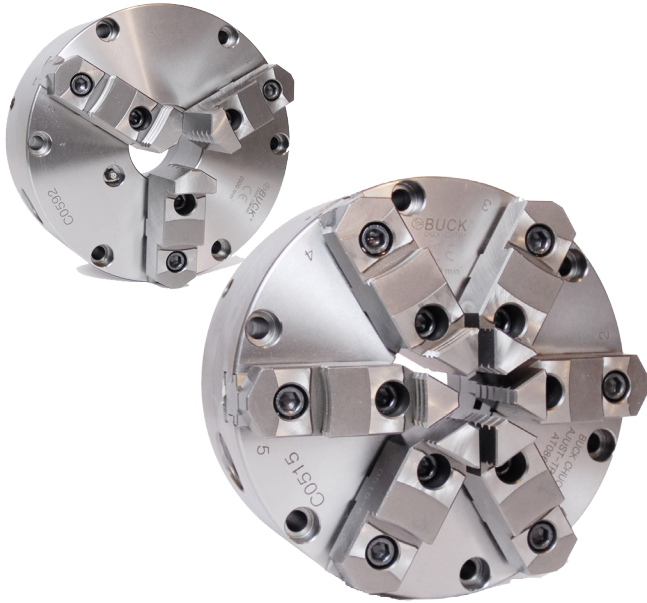

3-JAW

AT HARDENED TOP REVERSIBLE JAWS

Dia.	Part No.	A	B	C	D	E	F	G	H	J	K	L	M	P	Q	Gripping Dia. (in)		Max RPM	Wt. lb.
																EXT.	INT.		
6"	AT063RC	6.30	2.76	3.13	5.34	1.69	0.69	1/4-20	2.58	1.00	1.54	23/64	M12X1.75P	1.69	5/16	0.32-6.30	2.16-5.71	3000	18
8"	AT083RC	8.27	3.36	4.75	7.50	2.29	0.75	3/8-16	3.57	1.25	2.05	7/16	M12X1.75P	1.75	3/8	0.39-8.27	2.17-7.48	2500	46
10"	AT103RC	9.84	3.82	6.39	4.42	3.00	0.80	7/16-14	3.75	1.50	2.58	15/32	M12X1.75P	2.13	1/2	0.47-9.84	3.35-9.06	2000	72
12"	AT123RC	12.20	3.98	7.91	5.25	4.06	0.80	1/2-13	4.41	1.75	2.56	35/64	M12X1.75P	2.50	1/2	0.70-12.20	4.92-10.83	1500	118

6" jaws are not ANSI Standard- please contact us for details. Use inner bolt circle for 10" to 15" chuck sizes. Measurements in inches unless otherwise indicated.

6-JAW

AT HARDENED TOP REVERSIBLE JAWS

Dia.	Part No.	A	B	C	D	E	F	G	H	J	K	L	M	P	Q	Gripping Dia. (in)		Max RPM	Wt. lb.
																EXT.	INT.		
6"	AT066RC	6.30	2.76	3.13	5.34	1.69	0.69	1/4-20	2.58	1.00	1.54	23/64	M12X1.75P	1.69	5/16	0.98-6.30	2.95-5.71	1600	19
8"	AT086RC	8.27	3.36	4.75	7.50	2.29	0.75	3/8-16	3.57	1.25	2.05	7/16	M12X1.75P	1.75	3/8	0.78-8.27	2.56-7.48	1600	50
10"	AT106RC	9.84	3.82	6.39	4.42	3.00	0.80	7/16-14	3.75	1.50	2.58	15/32	M12X1.75P	2.13	1/2	0.47-9.84	3.54-9.06	1600	70
12"	AT126RC	12.20	3.98	7.91	5.25	4.06	0.80	1/2-13	4.41	1.75	2.56	35/64	M12X1.75P	2.50	1/2	1.57-12.20	4.53-10.831	1100	116



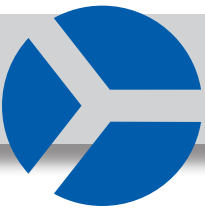

AT Scroll Chuck Mounting Plates

Adapt to all Current and Previous AT Models

Buck Chuck can also custom design adapter plates. If you do not see your spindle or mounting surface indicated here, please contact our sales office for assistance.

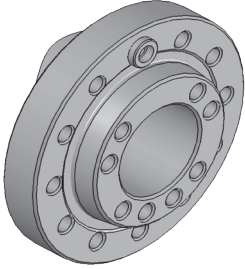

AMERICAN STANDARD • STYLE A1 & A2				
Spindle Size	Chuck Size			
	6	8	10	12
A-5	B6-A5	B8-A5	B10-A5	–
A-6	B6-A6	B8-A6	B10-A6	B12-A6
A-8	–	B8-A8	B10-A8	B12-A8
A-11	–	–	–	B12-A11

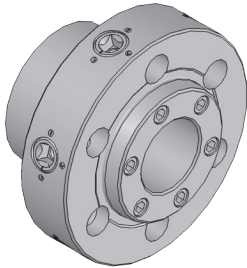

AMERICAN STANDARD • STYLE D1 CAMLOCK				
Spindle Size	Chuck Size			
	6	8	10	12
D-3	B6-D3	–	–	–
D-4	B6-D4	B8-D4	B10-D4	–
D-5	B6-D5	B8-D5	B10-D5	B12-D5
D-6	B6-D6	B8-D6	B10-D6	B12-D6
D-8	–	B8-D8	B10-D8	B12-D8
D-11	–	–	–	B12-D11

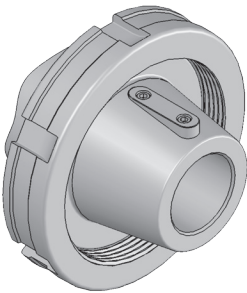

AMERICAN STANDARD • LONG TAPER STYLE L				
Spindle Size	Chuck Size			
	6	8	10	12
L-0	B6-L0	B8-L0	B10-L0	B12-L0
L-1	–	–	B10-L1	B12-L1
L-2	–	–	–	B12-L2

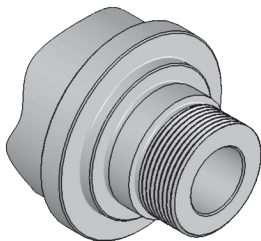

THREADED MOUNTING PLATES				
Spindle Size	Chuck Size			
	6	8	10	12
1-1/2"-8	AT-950	–	–	–
1-3/4"-8	AT-951	–	–	–
2-1/4"-8	–	AT-955	–	–

See Spindle Identification on page 6 to determine the correct mounting plate needed.

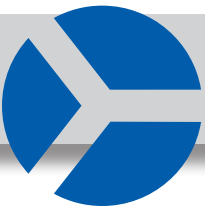

AT Scroll Chuck Mounting Plates

Adapt to all Current and Previous AT Models

Buck Chuck can also custom design adapter plates. If you do not see your spindle or mounting surface indicated here, please contact our sales office for assistance.

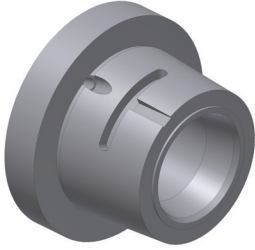

HARDINGE 4 DEGREE TAPER MOUNTING PLATES

Chuck Size	6"
Id #	B6-4

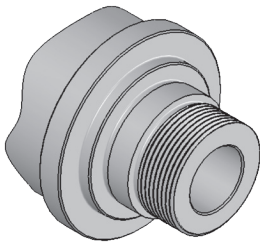

HARDINGE 2 3/16"-10 THREADED MOUNTING PLATES

Chuck Size	6"
Id #	B6-2 3/16"-10

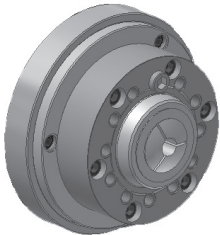

5C MOUNTING PLATE

Chuck Size	Part No.	Shank	(D) Flange	Hole Dia.	Length	Thread
6"	B6-5C	5C	6"	0.866	4.41	1.24" x 20

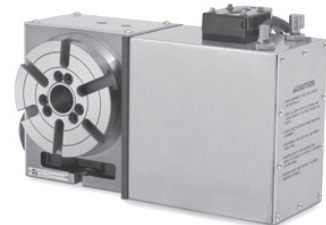

HRT ROTARY TABLE PLATES

Spindle	Chuck Size	Part Number
HRT160	6"	B6-HRT160
HRT210	8"	B8-HRT210
HRT310	10"	B10-HRT310

Adapters available for other Rotary Table models. Please contact our sales office.

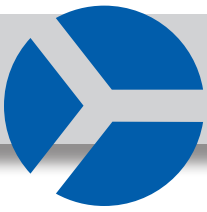

4-Jaw Independent Chucks

FEATURES & BENEFITS:

- Forged steel body
 - Heavy-duty
 - Four independently moving jaws allow for gripping irregular shapes
 - Adapter plates are available to fit most common spindles
 - 5" and 6" available with solid jaws only
 - 8" through 20" available with two piece jaws only
- All sizes available in solid jaw

CHUCK SHIPS COMPLETE WITH:

- One set of hard top jaws and master jaws or
- One set of solid reversible jaws
- One T-handle wrench
- Eye bolt for 16" and 20" chucks
- 10" to 20" chucks are provided with T-Slots

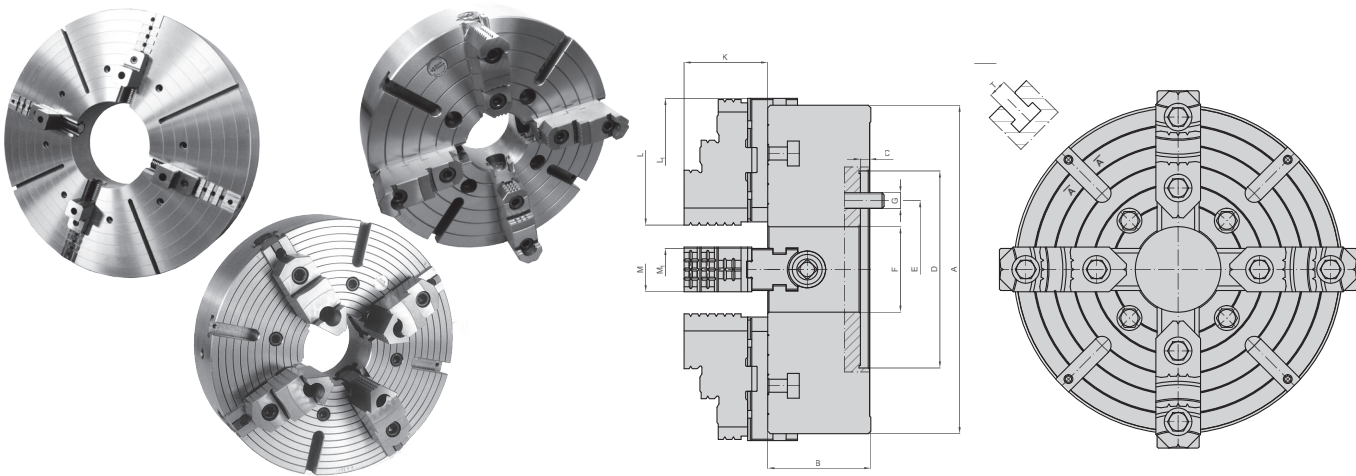

Dimensions	Chuck Size inch (millimeter)						
	IND1005T	IND1006ST	IND1008RT	IND1010RT	IND1012RT	IND1016RT	IND1020RT
A	5.12 (130.04)	6.14 (155.96)	7.87 (199.90)	9.84 (249.94)	12.40 (314.96)	15.75 (400.05)	19.68 (499.87)
B	1.69 (42.93)	1.69 (42.93)	2.85 (72.39)	3.09 (78.49)	3.42 (86.87)	3.62 (91.95)	4.21 (106.93)
C	0.10 (2.54)	0.10 (2.54)	0.19 (4.83)	0.27 (6.86)	0.27 (6.86)	0.39 (9.91)	0.47 (11.94)
D	2.75 (69.85)	3.25 (82.55)	4.33 (109.98)	5.90 (149.86)	6.89 (175.01)	7.87 (199.90)	10.63 (270)
E	2.12 (53.85)	2.75 (69.85)	3.25 (82.55)	4.12 (104.65)	5.25 (133.35)	6.75 (171.45)	9.25 (234.95)
F	1.02 (25.91)	1.65 (41.91)	1.97 (50.04)	2.56 (65.02)	3.15 (80.01)	3.93 (99.82)	4.92 (124.97)
G	4xM8	4xM10	4xM10	4xM12	4xM16	4xM16	4xM20
K	0.78 (19.81)	0.78 (19.81)	1.82 (46.23)	2.38 (60.45)	2.40 (60.96)	2.84 (72.14)	3.85 (97.79)
L	2.01 (51.05)	2.01 (51.05)	3.23 (82.04)	3.80 (96.52)	4.43 (112.52)	5.08 (129.03)	5.35 (135.89)
L1	_____	_____	3.11 (78.99)	3.70 (93.98)	4.33 (109.98)	5.08 (129.03)	6.61 (167.89)
M	0.63 (16)	0.63 (16)	1.34 (34.04)	1.34 (34.04)	1.65 (41.91)	1.65 (41.91)	2.12 (53.85)
M1	_____	_____	1.26 (32)	1.26 (32)	1.57 (39.88)	1.57 (39.88)	2.04 (51.82)
T	_____	_____	_____	0.55 (13.97)	0.71 (18.03)	0.71 (18.03)	0.86 (21.84)
Weight [lbs]	10.5	11.0	37.5	57.5	105.5	187	330
RPM max.	3500	3200	2500	2000	1500	1100	700
Clamping Range Min - Max [in]	0.31 - 4.92	0.31 - 6.30	0.39 - 7.87	0.39 - 9.84	0.59 - 12.40	0.79 - 15.75	1.77 - 19.69

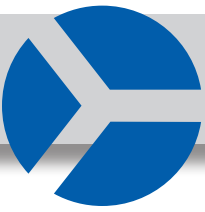

Independent Mounting Plates

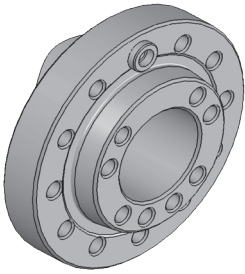

AMERICAN STANDARD • STYLE A1 & A2							
Spindle Size	Chuck Size						
	6	8	10	12	15	20	25
5	INDF6-A5	INDF8-A5	–	–	–	–	–
6	–	INDF8-A6	INDF10-A6	INDF12-A6	INDF15-A6	–	–
8	–	–	–	INDF12-A8	INDF15-A8	INDF20-A8	–
11	–	–	–	–	INDF15-A11	INDF20-A11	–

If you do not see your spindle mount indicated here, please contact our sales office for more information.

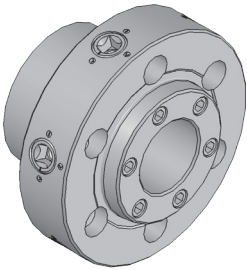

AMERICAN STANDARD • STYLE D CAMLOCK							
Spindle Size	Chuck Size						
	6	8	10	12	15	20	25
4	INDF6-D4	INDF8-D4	–	–	–	–	–
5	–	–	–	–	–	–	–
6	–	INDF8-D6	INDF10-D6	–	INDF15-D6	–	–
8	–	–	INDF10-D8	INDF12-D8	–	INDF20-D8	–
11	–	–	–	INDF12-D11	INDF15-D11	INDF20-D11	–

If you do not see your spindle mount indicated here, please contact our sales office for more information.

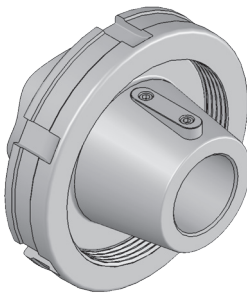

AMERICAN STANDARD • LONG TAPER STYLE						
Spindle Size	Chuck Size					
	6	8	10	12	15	20
L-00	IND6-L00	IND8-L00	IND10-L00	–	–	–
L-0	IND6-L0	IND8-L0	IND10-L0	IND12-L0	–	–
L-1	–	IND8-L1	IND10-L1	IND12-L1	IND15-L1	–
L-2	–	–	–	IND12-L2	IND15-L2	IND20-L2
L-3	–	–	–	–	IND15-L3	–

Plates unfinished only.

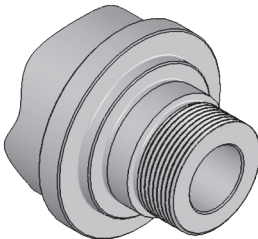

THREADED MOUNTING PLATES						
Spindle Size	Chuck Size					
	4	5	6	8	10	12
1"-10	IND4-110	–	–	–	–	–
1 1/2"-8	IND4-1508	IND5-1508	IND6-1508	IND8-1508	–	–
2 3/16"-10	–	IND5-2316	IND6-2316	–	–	–
2 1/4"-8	–	IND5-2258	IND6-2258	IND6-2258	–	–

Plates unfinished only.

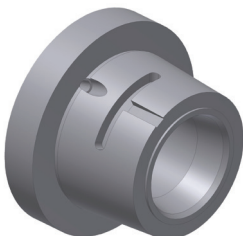

HARDINGE 4 DEGREE TAPER • FULLY FINISHED	
5"	INDF5-4DEG
6"	INDF6-4DEG

See Spindle Identification on page 6 to determine the correct mounting plate needed.



Forged Steel Low Profile Chucks

3 Jaw Round and 4 Jaw Square

FEATURES:

- Precision ground, tolerances within 0.05mm
- Soft jaws can be used, allowing for versatility in machining
- Repeatability of 0.02mm with the standard hard jaws
- Parallel gripping accuracy with hard jaws can be controlled within 0.05mm after aligning sides of chucks

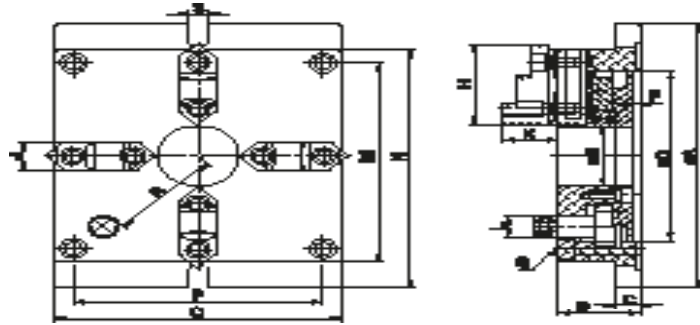
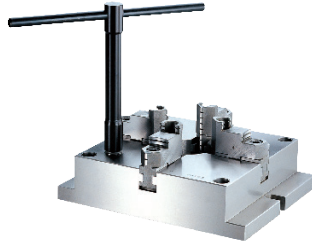

4-JAW

4-Jaw Square Chuck

	Part No.	A	B	C	D	E	F	G	H	J	K	L	M	N	P	Q	R	S	Gripping Dia. (mm)		Wt. Lbs.
																			EXT.	INT.	
6"	MC-06	8.46	2.24	0.71	5.12	1.57	0.22	(4) M10x1.5P	2.68	1.02	0.55	5.67	6.50	5.67	6.50	2.60	2.60	0.71	4-128	55-128	25
8"	MC-08	9.84	2.56	0.79	6.30	2.17	0.24	(4) M12x1.75P	3.23	1.10	0.67	6.85	7.87	6.85	7.87	3.27	3.27	0.71	5-162	62-162	41
10"	MC-10	12.20	2.83	0.87	7.87	2.76	0.24	(4) M14x2P	3.66	1.26	0.83	8.58	9.84	8.58	9.84	4.09	4.09	0.71	6-200	72-200	71
12"	MC-12	14.96	3.35	0.98	10.24	3.94	0.28	(4) M16x2P	4.65	1.57	0.91	10.79	12.20	10.79	12.20	5.31	5.31	0.87	10-265	90-265	126

FEATURES:

- Wrench inserted at 30 ° angle allowing for versatility in placement of chuck
- Super-thin design increases allowable distance of machining operations
- Flange mount makes unloading and loading operations simple and convenient
- Hard or soft top jaws can be used

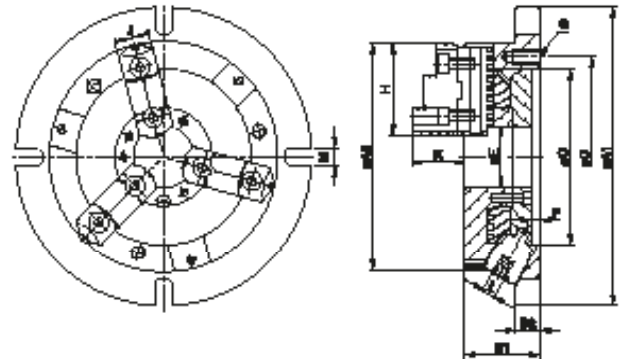
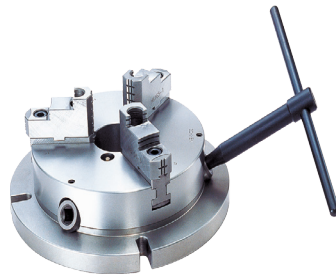

3-JAW

3-Jaw Round Chuck

	Part No.	A1	A2	B1	B2	C	D	E	F	G	H	J	K	L	M	Gripping Dia. (mm)		Weight Lbs.
																EXT.	INT.	
6"	NBK-06	8.66	6.69	2.28	0.71	5.12	5.79	1.77	0.24	(3) M10x1.5P	2.68	1.02	1.57	0.39	0.51	8-160	48-150	24
8"	NBK-08	10.63	8.27	2.56	0.79	6.10	6.77	2.36	0.24	(3) M10x1.5P	3.23	1.10	1.69	0.43	0.51	11-200	62-190	40
10"	NBK-10	12.40	255	2.87	0.79	7.48	8.27	3.15	0.24	(3) M12x1.75P	3.66	1.26	2.05	0.47	0.63	12-250	72-240	61
12"	NBK-12	14.57	10.04	3.15	0.87	9.84	11.22	4.13	0.20	(3) M12x1.75P	4.65	1.57	2.32	0.55	0.71	15-300	86-290	95

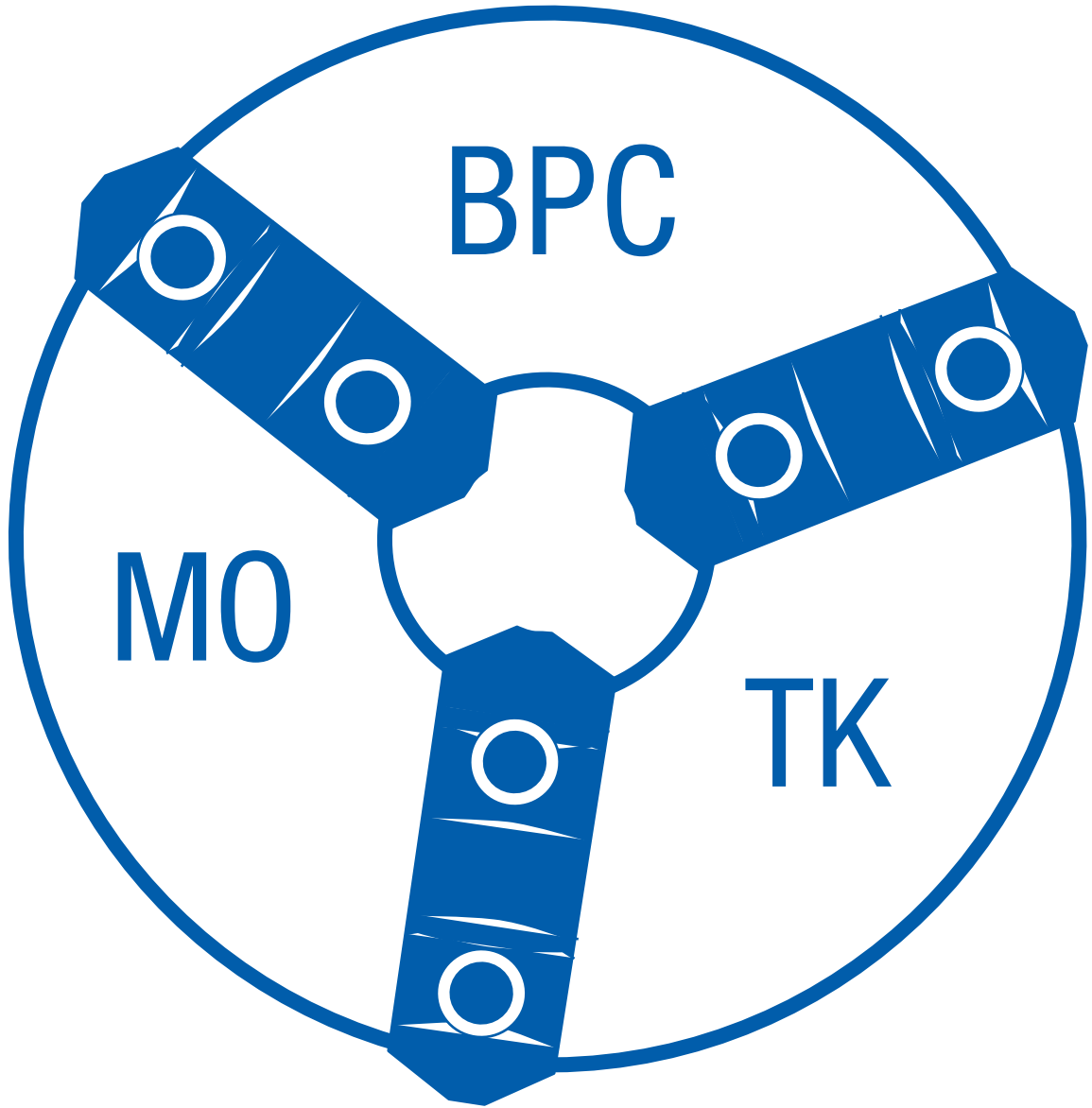
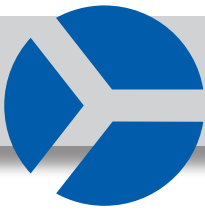

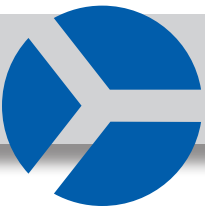

TK Air-Operated 3-Jaw Power Chucks



Also available in 2-Jaw.



REQUIRES
Air Feed Tube and ADP adapter

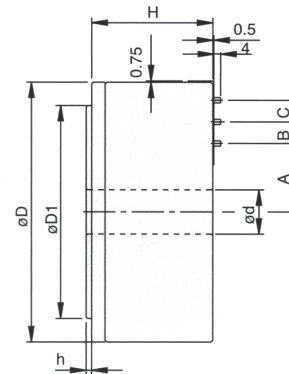
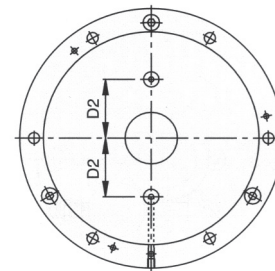
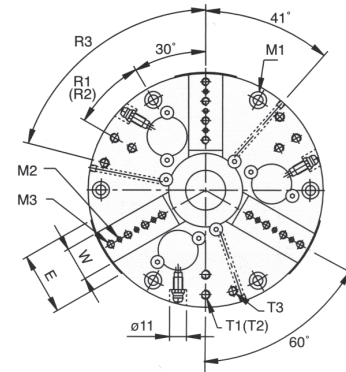

CHUCK SHIPS COMPLETE WITH:

- One set of soft top jaws
- Wrench

Model	A	B	C	D	E	D1	d (H7)	D2
TK-04	20.75	12.7	12.7	101.6	30	82.55	18	25.0
TK-06	39.75	12.7	12.7	152.4	40	124.97	26	34.5
TK-08	65.75	25.4	–	203.2	45	167.64	50	50.0

Model	H	H	W	M1	M2
TK-04	70.3	3.2	16	M5x0.8P(PCDø88.9)	M5x0.8P
TK-06	70.3	3.2	22	M6x1P(PCDø135.89)	M5x0.8P
TK-08	99.5	7.0	25	M10x1.5P(PCDø182.88)	M10x1.5P

Model	M3	T1	T2
TK-04	9-3.18	M5x0.8P(PCDø88.9)	–
TK-06	9-3.18	M6x1P(PCDø135.99)	M6x1P(PCDø110)
TK-08	6-6.36	M8x1.25P(PCDø182.88)	M8x1.25P(PCDø150)

Model	T3	R1	R2	R3	T.I.R. Jaw T.I.R.	Jaw Stroke Dia. (mm)
TK-04	–	30°	–	–	0.001	3
TK-06	M6x1P(PCDø135.99)	30°	30°	45°	0.001	3
TK-08	M8x1.25P(PCDø182.88)	30°	30°	30°	0.001	3

Model	Repeatability	Gripping Force At Air Pressure 100 psi (lb.)	Max. Speed rpm (min ⁻¹)	Weight (lb.)
TK-04	0.001	683	4500	10
TK-06	0.001	1741	4500	22
TK-08	0.001	3196	4500	58

FEATURES AND BENEFITS:

- Pre-machined tapped holes for fixing jigs, making additional machining unnecessary
- Pre-machined lubrication path allows connection to auto-lubrication unit
- Built-in cylinder allows more stable gripping
- Dowel pins built into master jaws allow for more accurate and simplified remounting of soft jaws
- Good coaxiality and repeatability allows for 1µm accuracy, which simplifies machining process and increases efficiency

Measurements in millimeters unless otherwise indicated.



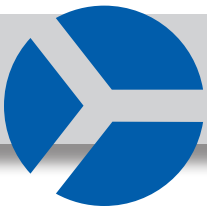

MO Stationary Closed Center 3-Jaw Power Chuck

Self-Contained Wedge Type



Also available in 2-Jaw.

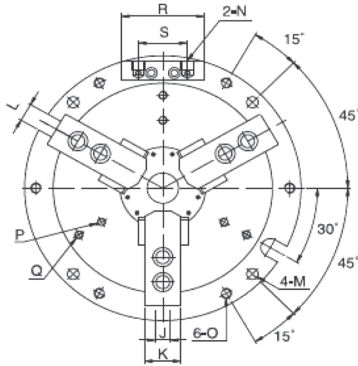

FEATURES AND BENEFITS:

- Flange bottom allows chuck to be easily fixed on a plate for quick changeovers
- Built-in cylinder allows for better stability and takes up less space, which allows for higher machining efficiency
- Chuck can be controlled by M-code for use in an auto loading system
- Master jaws with 1.5 mm X 60° pitch enables hard and soft jaw interchangeability with CNC lathe chucks, allowing reduction in cost of spare jaws
- Dust-proof and water-resistant structure increases chuck life and efficiency

CHUCK SHIPS COMPLETE WITH:

- One set of soft top jaws
- Wrench

MO 3-JAW WEDGE TYPE POWER CHUCK

Model	A	B	C	D	E	F	G	H	I	J	K
MO-04	155	115	–	15	77.5	103.5	26	49.5	14	10	23
MO-05	185	135	–	15	95	128	33	62	14	10	25
MO-06	224	169	25	16	118	158	40	73	20	12	31
MO-08	265	210	30	20	138	180	42	95	25	14	35
MO-10	315	254	52	23	150	196	46	110	30	16	40
MO-12	375	304	80	23	165	219	54	129	30	21	50

MO 3-JAW WEDGE TYPE POWER CHUCK

Model	L	M	N	O	P	Q	R	S
MO-04	13	9 (PCD 165)	PT1/8	M8x1.25P	–	–	64	47
MO-05	13	10 (PCD 135)	PT1/4	M8x1.25P	M8x1.25P	–	80	47
MO-06	18	11 (PCD 202)	PT1/4	M10x1.5P	M8x1.25P	–	80	47
MO-08	18	11 (PCD 243)	PT1/4	M10x1.5P	M10x1.5P	M10x1.5P	80	47
MO-10	18	13 (PCD 285)	PT1/4	M12x1.75P	M12x1.75P	M12x1.75P	80	47
MO-12	18	17 (PCD 340)	PT3/8	M16x2P	M12x1.75P	M12x1.75P	80	55

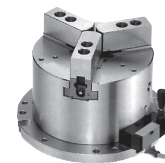
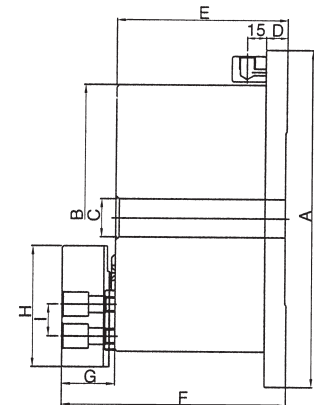

OPTIONAL ACCESSORIES

- Pneumatic
- Manual switch

MO 3-JAW WEDGE TYPE POWER CHUCK

Model	Piston Area (cm ²)	Plunger Stroke (mm)	Jaw Stroke Dia. (mm)	Max. Gripping Force (lb.)	Max. Hydr. Pressure (psi)	Gripping Force at Air Pressure 100 psi (lb.)	Gross Weight (lb.)	Gripping Range (mm)
MO-04	57	9	3.8	5291	213	2425	22	9-115
MO-05	74	10	5.4	7242	284	2866	25	12-135
MO-06	97	12	5.5	11111	284	4409	46	15-169
MO-08	156	16	7.4	17857	284	7275	81	20-210
MO-10	235	19	8.8	26918	284	10582	124	33-254
MO-12	292	23	10.6	31967	284	11243	154	40-304

Dimensions denoted in millimeters unless otherwise specified.

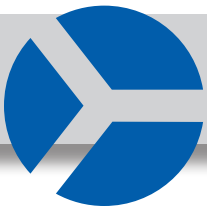

BPC High-Speed, Thru-Hole 3-Jaw Power Chuck

Wedge Type - Direct OEM Replacement

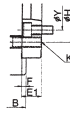
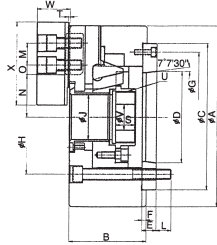
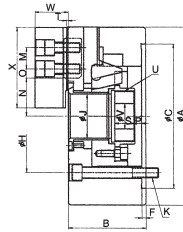
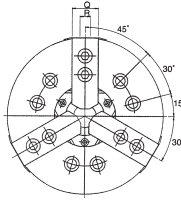

FEATURES & BENEFITS:

- High-quality alloy steel body allows for higher speeds
- Sharply increased dynamic gripping force greatly improves work efficiency and safety
- Interchangeable top tooling with 1.5 mm x 60° jaw serration pitch
- Compact and lightweight, allowing for improved efficiency
- Direct mounting to fit ASA B5.9 Type A spindle
- Improved lubrication system for high accuracy and endurance
- Heat-treated alloy steel for high durability

CHUCK SHIPS COMPLETE WITH:

- ASA B5.9 Type A spindle adapter
- 1 set of soft top jaws
- Wrench

MODEL OP 3-JAW WEDGE TYPE POWER CHUCK

Model	Spindle Nose	A	B	C	D	E	E1	F	G	H	H1	I1	J	K	L	M	N Max.	N Min.
BPC204	—	110	59	85	—	—	—	4	—	70.6	—	—	26	M10x1.5p	—	14	23	20.3
BPC205	A2-4	135	60	110	63.51	20	—	4	96	82.6	PCD118	M8x1.25P	33	M10x1.5P	15	14	26.20	23.50
BPC206	A2-5	169	81	140	82.56	15	—	5	116	104.8	PCD145	M10x1.5P	45	M10x1.5P	16	20	32.35	29.60
BPC208	A2-6 (A2-5)	210	91	170	106.98	17	23	5	150	133.4	PCD180	M10x1.5P	52	M12x1.75P	18	25	39.10	35.40
BPC210	A2-8 (A2-6)	254	100	220	139.72	18	28	5	190	171.4	PCD225	M12x1.75P	75.0	M16x2P	19	30	51.5	47.1
BPC212	A2-8 (A2-6)	304	110	220	139.72	18	—	6	190	171.4	PCD250	M12x1.75P	91.0	M16x2P	25	30	61.6	56.3
BPC215	A2-11 (A2-8)	381	133	300	196.87	22	33	6	260	235.0	PCD324	M12x1.75P	117.5	M20x2.5P	28	43	82.3	77.0
BPC218	A2-11 (A2-8)	450	133	300	196.87	22	33	6	260	235.0	PCD230	M12x1.75P	120.0	M20x2.5P	28	43	83.8	78.5

SPECIFICATIONS CONTINUED

Model	O Max.	O Min.	P Max.	P Min.	Q	R	S	T	U	V	W	X	Y	Thru-Hole Dia.	Plunger stroke (mm)
BPC204	11.5	6.7	3.5	-6.5	23	10	17.5	2	M32X1.5P	12	24	49.5	--	26	
BPC205	19.0	6.0	1.0	-9.0	25	10	20.0	2	M40x1.5P	12	31.5	62.0	—	33.0	10
BPC206	24.0	7.0	11.0	-1.0	31	12	19.0	2	M55x2P	20	37.0	73.0	—	45.0	12
BPC208	30.0	10.0	14.5	-1.5	35	14	20.5	2	M60x2P	30	39.0	95.0	104.8	52.0	16
BPC210	34.0	12.0	8.5	-10.5	40	16	25.0	2	M85x2P	40	43	110	133.4	75.0	19
BPC212	46.0	12.0	8.0	-15.0	50	21	28.0	2	M100x2P	50	51	129	—	91.0	23
BPC215	46.0	13.0	7.0	-16.0	62	22	42.5	5	M130x2P	48	66	165	171.4	117.5	23
BPC218	78.0	18.0	7.0	-16.0	62	22	42.5	5	M130x2P	48	66	165	171.4	120.0	23

SPECIFICATIONS CONTINUED

Model	Jaw Stroke Dia. (mm)	Max. Speed (rpm)	Gross Weight (lb.)	Max. Pull Force (lb.)	Max. Gripping Force (lb.)	Max. Hydr. Pressure (psi)	Gripping Range (mm)		Draw Nut Thread (mm)	Matching Cylinder
							Min.	Max.		
BPC204	5.4	8000		3147	6294	334	7	110	M32X1.5P	BC1036
BPC205	5.4	7000	13	3814	7870	412	10	135	M40x1.5P	BC1036
BPC206	5.5	6000	28	4718	12588	398	13	169	M55x2P	BC1246
BPC208	7.4	5000	48	7408	18430	370	13	210	M60x2P	BC1552
BPC210	8.8	4200	74	9436	24273	384	30	254	M85x2P	BC1875
BPC212	10.6	3300	122	12125	31702	384	35	304	M100x2P	BC2091
BPC215	10.6	2500	235	15741	40234	348	35	381	M130x2P	BC2511
BPC218	10.6	2000	250	15741	40234	348	40	450	M130x2P	BC2511

Dimensions denoted in millimeters unless otherwise specified.

Specially threaded or blank draw nuts available



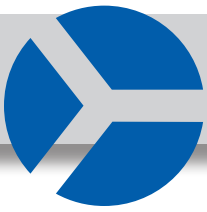

BBC High-Speed, Large Bore 3-Jaw Power Chuck

Wedge Type - Direct OEM Replacement

FEATURES & BENEFITS:

- High-quality alloy steel body allows for higher speeds
- Sharply increased dynamic gripping force greatly improves work efficiency and safety
- Interchangeable top tooling with 1.5 mm x 60° jaw serration pitch
- Compact and lightweight, allowing for improved efficiency
- Direct mounting to fit ASA B5.9 Type A spindle
- Improved lubrication system for high accuracy and endurance
- Heat-treated alloy steel for high durability

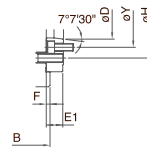
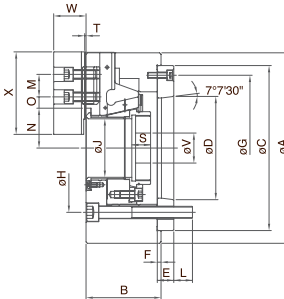
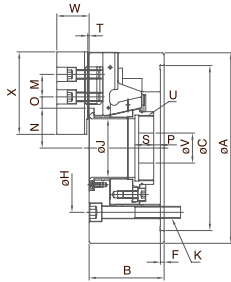
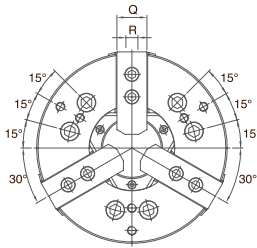

MODEL BBC 3-JAW WEDGE TYPE POWER CHUCK

Model	Spindle Nose	A	B	C	D	E	E1	F	G	H	J	K	L	M	N Max.	N Min.
BBC206	A2-5	170	81	140	82.6	--	20	5	--	PCD122	45	M10x1.5P	--	20	36.4	33.6
BBC208	A2-6	215	91	170	106.4	--	22	5	--	PCD150	52	M12x1.75P	--	25	46.6	42.9
BBC210	A2-8	256	100	220	139.7	--	28	5	--	PCD180	81	M16x2P	--	30	54.6	50.1
BBC212	A2-11(A2-8)	315	108	300	196.9	22	33	5	260.0	PCD235	106	M20x2.5P	27	30	69.7	64.3
BBC215	A2-15(A2-11)	405	133	380	285.8	27	41	6	330.2	PCD330.2	142	M24x3P	32	43	95.1	89.5
BBC218	A2-15(A2-11)	455	134	380	285.8	27	41	6	330.2	PCD330.2	166.5	M24x3P	32	43	108.3	102.5

SPECIFICATIONS CONTINUED

Model	O Max.	O Min.	P Max.	P Min.	Q	R	S	T	U	V	W	X	Y	Thru-Hole Dia.	Plunger stroke (mm)
BBC206	21.1	9.1	7.0	-5.0	31	12	23.0	2	M60x2P	20	37.5	73	104.8	52	12
BBC208	26.6	11.6	10.0	-6.0	35	14	25.0	2	M75x2P	30	39.5	80	133.4	66	16
BBC210	33.1	13.6	8.5	-10.5	40	16	25.0	2	M90x2P	40	43	110	171.4	81	19
BBC212	45.6	12.6	8.0	-15.0	50	21	28.0	2	M115x2P	50	51	129	171.4	106	23
BBC215	43.6	16.6	8.0	-15.0	62	22	42.5	5	M155x2P	80	66	165	235	142	23
BBC218	55.6	16.6	11.5	-13.0	62	22	38.0	5	M180x3P	48	66	165	171.4	120.0	23

SPECIFICATIONS CONTINUED

Model	Jaw Stroke Dia. (mm)	Max. Speed (rpm)	Gross Weight (lb.)	Max. Pull Force (lb.)	Max. Gripping Force (lb.)	Max. Hydr. Pressure (psi)	Gripping Range (mm)		Draw Nut Thread (mm)	Matching Cylinder
							Min.	Max.		
BBC206	5.5	6000	28	4850	13007	298	13	1710	M60x2P	BC1452S
BBC208	7.4	5000	48	7495	19400	370	50	215	M75x2P	BC1666S
BBC210	8.8	4200	74	9479	24471	412	34	254	M90x2P	BC1881S
BBC212	10.6	3400	122	12345	32143	256	50	315	M115x2P	BC2511
BBC215	10.6	2500	235	15961	40234	370	60	405	M155x2P	BC2816
BBC218	11.3	2000	250	15961	40234	370	80	455	M180x3P	BC2816

Dimensions denoted in millimeters unless otherwise specified.

Specially threaded or blank draw nuts available

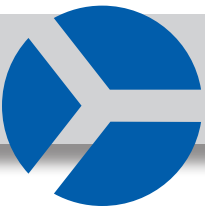

Super High-Speed Hollow Rotary

Model BC Hydraulic Cylinders

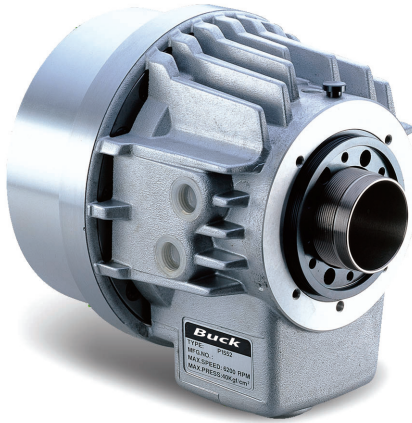

FEATURES INCLUDE:

- Compact & Lightweight
- Large Thru-Hole Diameter
- Built-In Check-Valve
- Easy for Heat Dissipation

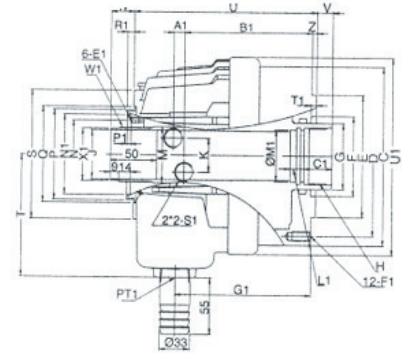
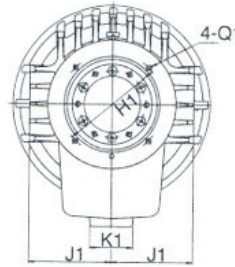

Model	A1	B1	C	C1	D	E	E1	F	F1	G	G1	H	H1	J	J1	K	K1	L1
BC1036	11	102.5	135	25	115	100	M5x0.8	65	M10x1.5	48	98	M42x1.5	88	36	73	30	47	15
BC1246	11.5	126.5	155	30	130	100	M6x1.0	80	M10x1.5	65	135	M55x2.0	98	46	76	36	47	15
BC1552	12	136	190	30	170	130	M6x1.0	85	M10x1.5	70	145	M60x2.0	110	52	86	36	47	15
BC1875	17.5	153.5	215	35	190	160	M6x1.0	120	M10x1.5	95	166.5	M85x2.0	155	75	101	36	47	15
BC2091	21	168	240	35	215	180	M6x1.0	140	M12x1.75	110	183	M100x2.0	165	91	110	36	47	15
BC2511	23	176.5	305	45	275	230	M6x1.0	-	M16x2.0	140	193	M130x2.0	215	118	-	40	-	15

Model	M	M1	N	N1	P	P1	Q	Q1	R1	S	S1	T	T1	U	U1	V Max.	V Max.	W Max.	W1	W Max.	X1	Z
BC1036	44.6	38	55	64	73	4	45	M5x0.8	5	104	PT3/8	115	6	161	150	10	-5	40	M44x1.5	25	42	5
BC1246	52.9	50	64	76	85	4	90	M5x0.8	6	118	PT1/2	115	6	184	170	10	-5	40	M52x1.5	25	50	5
BC1552	59.6	55	73	85	96	4	102	M6x1.0	7	137	PT1/2	130	6	196	210	17	-5	47	M58x1.5	25	56	5
BC1875	84.6	80	98	108	121	4	131	M6x1.0	7	166	PT1/2	160	6	230	235	20	-5	50	M84x2.0	25	81	5
BC2091	99.6	95	108	120	138	4	148	M6x1.0	7	182	PT1/2	185	6	253	260	25	-5	55	M99x2.0	25	96	5
BC2511	133.6	-	148	195	-	5	-	M6x1.0	-	230	PT1/2	210	-	275	315	25	-5	52	-	-	-	-

Model	Thru-Hole Dia. (mm)	Piston Stroke (mm)	Max. Speed (rpm)	Gross Weight (kg)	GD ² (kfg-m ²)	Piston Dia. (mm)	Oil Leakage Rate (O/min)	Max. Speed (kfg/cm ²)	Piston Area (cm ²)		Operating Force Max. (psi)	
									Push Side	Pull Side	Push Side	Pull Side
BC1036	36	15	8000	8.8	0.044	105	3.0	40	67	64.5	2500	2400
BC1246	46	15	7000	13.8	0.078	125	3.0	40	100	89	3700	3200
BC1552	52	22	6200	19.3	0.21	155	3.9	40	161	150	5900	5500
BC1875	75	25	4700	28.5	0.38	180	4.2	40	198	183	7200	6700
BC2091	91	30	3800	36.1	0.61	205	4.5	40	252	234	9200	8600
BC2511	118	30	2800	54	1.5	250	7.0	40	345	335	-	-

Note: Specifications subject to change without notice. *12" Bore - 6 additional holes on a 9.50 B.C. Dimensions denoted in millimeters unless otherwise specified.

Compatible with chucks on pages 22, and 24

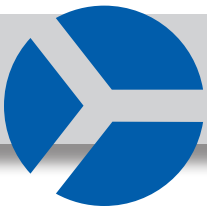

CL High-Speed Closed Center 3-Jaw Power Chuck

Wedge Type - Direct OEM Replacement

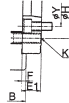
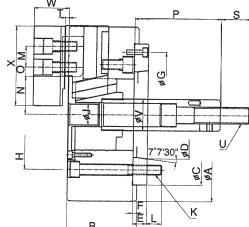
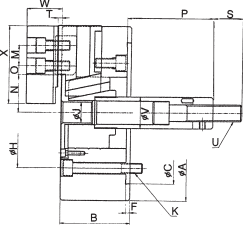
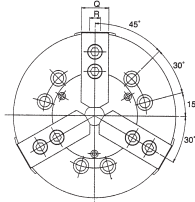
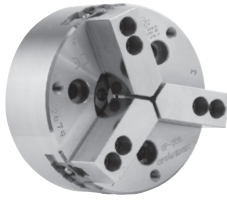

FEATURES AND BENEFITS:

- High-quality alloy steel body allows for high speeds
- Sharply increased dynamic gripping force greatly improves work efficiency and safety
- Interchangeable top tooling with 1.5 mm x 60° jaw serration pitch
- Compact and lightweight, allowing for increased efficiency
- Direct mounting to fit ASA B5.9 Type A spindle
- Improved lubrication system for high-accuracy and endurance
- Heat-treated alloy steel for high durability

CHUCK SHIPS COMPLETE WITH:

- ASA B5.9 Type A spindle adapter
- 1 set of soft top jaws
- Wrench

MODEL CL 3-JAW WEDGE TYPE POWER CHUCK

Model	Nose of Spindle	A	B	C	D	E	E1	F	G	H	J	K	L	M	Nmax	Nmin
CL-05	A ₂ -4	135	55	80	63.51	—	—	7	—	100.0	—	M8x1.5P	14	14	30.4	27.20
CL-06	A ₂ -5	165	74	140	82.56	15	—	5	116	104.8	21	M10x1.5P	14	20	37.8	33.25
CL-08	A ₂ -6 (A ₂ -5)	210	85	170	106.38	17	23	5	150	133.4	25	M12x1.75P	18	25	46.3	41.90
CL-10	A ₂ -8 (A ₂ -6)	254	89	220	139.72	18	28	5	190	171.4	34	M16x2P	25	30	51.4	47.00
CL-12	A ₂ -8	304	106	220	139.72	18	—	6	190	171.4	34	M16x2P	25	30	60.7	55.45
CL-15	A ₂ -11	381	114	300	196.87	22	—	6	260	235.0	—	M20x2.5P	32	43	77.5	69.50
CL-18	A ₂ -11	450	114	300	196.87	22	—	6	260	235.0	—	M20x2.5P	32	43	108.0	100.00

SPECIFICATIONS CONTINUED

Model	Omax	Omin	Pmax	Pmin	Q	R	S	T	U	V	W	X	Y
CL-05	17.00	7.00	9.0	-6.0	25	10	35	2	M12x1.75P	28	31	62	—
CL-06	18.00	7.50	101.5	81.5	31	12	36	4	M16x2P	34	39	73	—
CL-08	22.50	9.00	127.0	106.0	35	14	36	5	M20x2.5P	38	42	95	—
CL-10	37.50	10.50	158.0	133.0	40	16	36	5	M20x2.5P	45	46	110	104.8
CL-12	47.00	11.00	163.0	133.0	50	18.0	36	5	M20x2.5P	50	54	130	133.4
CL-15	50.25	23.25	104.0	69.0	62	25.5	55	2	M30x3.5P	60	63	165	—
CL-18	49.50	25.50	92.0	57.0	62	25.5	55	2	M30x3.5P	60	63	165	—

SPECIFICATIONS CONTINUED

Model	Plunger Stroke (mm)	Jaw Stroke Dia. (mm)	Max RPM	Max Pull Force (lb.)	Max Grip Force (lb.)	Max Hydr. Pressure (psi)	Weight (lb.)	Grip Range (mm) Min.	Grip Range (mm) Max.
CL-05	15	6.4	5500	1764	5401	312	13	8	135
CL-06	20	8.5	5000	3813	11464	384	25	18	165
CL-08	21	8.8	4600	5379	16402	355	48	12	210
CL-10	25	8.8	4000	6283	23831	412	74	16	254
CL-12	30	10.5	3200	8994	34171	412	129	18	304
CL-15	35	16.0	2800	18210	55754	462	222	68	381
CL-18	25	16.0	2500	18210	55754	462	250	85	450

Dimensions denoted in millimeters unless otherwise specified.

Available in larger sizes and two-jaw model. Please contact our sales office for more information.



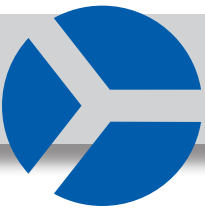

Super Life 3-Jaw Stationary Power Chuck

The Original Buck Power Chuck – Stationary Hydraulic/Pneumatic



FEATURES AND BENEFITS:

- Stationary hydraulic/pneumatic built-in cylinder uses less space, while increasing stability and machining efficiency
- Ideal for CNC machining centers as well as standard mills and grinders
- Designed with a sealed face to help protect internal parts from abrasion for a longer service life in the most demanding applications
- Guaranteed repeatability of .001" TIR or better on duplicate part production
- Wear plates under master jaws are easily shimmed or replaced to restore original accuracy

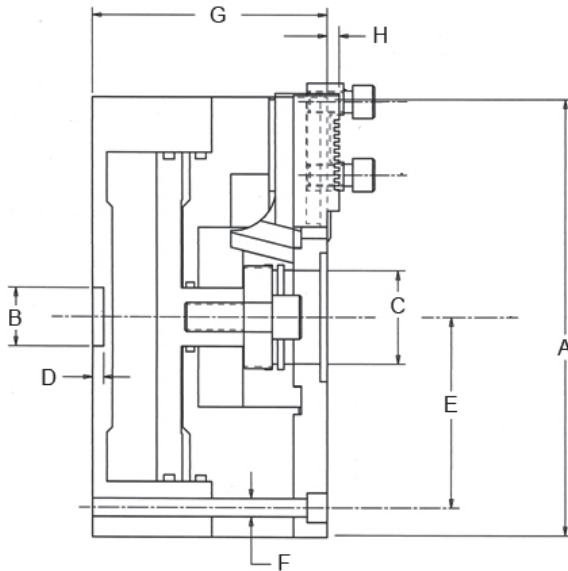

NOTES:

- Featured with American Square Serrated Master Jaws (other jaw styles available)
- Available with or without a Thru-Hole; available in 2-Jaw, 3-Jaw or 2/3-Jaw styles
- Also available in a lightweight aluminum body
- Parts available for previous models – contact our sales office for more information
- Made in the USA

STATIONARY HYDRAULIC/PNEUMATIC 3-JAW POWER CHUCK

Model	A	B	C	D	E	F	G	H	Jaw Travel	Max Drawbar Pull (lb.)	Max Line Pressure (psi)
A5606	6.50	2.00	1.00	0.25	2.88	0.41	5.19	0.16	0.25	2800	166
A5608	8.25	2.00	1.50	0.22	3.72	0.34	5.78	0.16	0.25	5000	170
A5610	10.00	2.00	2.00	0.31	4.50	0.53	6.37	0.31	0.25	9000	195
A5612	12.00	2.00	2.00	0.31	5.38	0.53	6.25	0.19	0.25	10500	160
A5615	15.00	2.00	3.18	0.31	6.75	0.66	8.06	0.38	0.25	15000	160
A5618	18.00	2.00	3.18	0.31	8.00	0.66	8.06	0.38	0.25	15000	105
A5624	24.00	2.00	3.75	0.50	9.38	0.78	9.50	0.31	0.25	15000	50

Measurements in inches unless otherwise indicated.

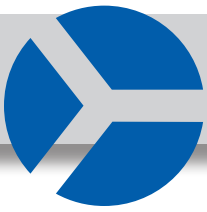

Super Life 3-Jaw Power Chuck

The Original Buck Power Chuck – Hydraulic Sliding Jaw

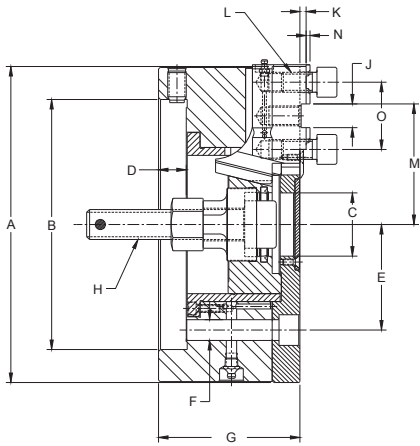
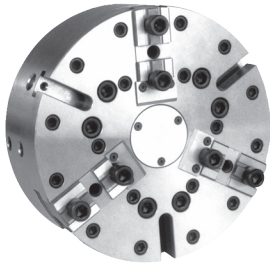

FEATURES AND BENEFITS:

- Adjust-Tru® Precision! Dead-zero precision mounting feature for “near-zero” runout
- Wide keyway to increase bearing surfaces, lessen wear and increase stability
- Hardened and ground steel wear surfaces increase service life
- Guaranteed repeatability of .001" TIR or better on duplicate part production
- Wear plates under master jaws are easily shimmed or replaced to restore original accuracy
- Hardened replaceable wedge bushings available for factory or field replacement; simple grinding restores wedge to original fit
- 4-to-1 mechanical advantage in all chuck sizes

NOTES:

- Featured with tongue & groove master jaws
Other jaw styles available
- Available with or without a Thru Hole
- Available in 2-Jaw, 3-Jaw or 2/3-Jaw styles
- Also available in lightweight aluminum body
- Parts available for previous models – please contact our sales office for more information
- Adjust-Tru® power chuck mounting plate required
- Made in the USA

SUPER LIFE 3-JAW MODEL POWER CHUCK

Model	A	B	C	D	E	F	G	H	J	K	L	M (max)	M (min)	N	O
A4006	6.50	4.78	1.00	0.63	2.06	0.47	3.25	5/8"-18	0.50	0.16	7/16"-14	2.44	2.19	0.13	1.50
A4008	8.25	6.16	1.50	0.66	2.63	0.53	3.86	5/8"-18	0.50	0.16	1/2"-13	3.06	2.75	0.13	1.75
A4010	10.00	7.91	2.00	0.88	3.38	0.69	4.47	1"-14	0.75	0.19	5/8"-11	3.81	3.44	0.13	2.13
A4012	12.00	7.91	2.00	0.88	3.38	0.69	4.47	1"-14	0.75	0.19	5/8"-11	4.50	4.13	0.13	2.50
A4015	15.00	11.78	3.19	0.94	4.63	0.78	5.16	1"-14	0.75	0.28	3/4"-10	5.63	5.25	0.13	3.00
A4018	18.00	11.78	3.19	0.94	4.63	0.78	5.16	1"-14	0.75	0.28	3/4"-10	5.63	5.25	0.13	3.00
A4021	21.00	16.03	3.75	1.19	6.50	0.94	6.50	1"-14	0.75	0.31	3/4"-10	7.13	6.63	0.13	3.00
A4024	24.00	16.03	3.75	1.19	6.50	0.94	6.50	1"-14	0.75	0.31	3/4"-10	7.13	6.63	0.13	3.00

SPECIFICATIONS CONTINUED

Model	Jaw Travel	Max Drawbar Force (lb.)	Max RPM	Wedge Travel (in.)	Total Compensation	Weight (lb.)
A4006	0.25	1900	4000	1.00	0.13	26
A4008	0.31	3300	3500	1.25	0.13	55
A4010	0.38	6000	3000	1.50	0.25	92
A4012	0.38	7000	2500	1.50	0.25	133
A4015	0.38	10000	2000	1.50	0.25	218
A4018	0.38	10000	1500	1.50	0.25	331
A4021	0.50	10000	1200	2.00	0.25	570
A4024	0.50	10000	1000	2.00	0.25	748

Note: Actuation Packages may be needed. Please contact our sales office for more information. Measurements in inches unless otherwise indicated.

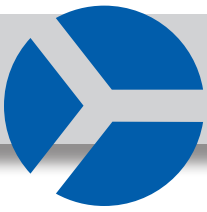

Super Life 2/3-Jaw Power Chuck

The Original Buck Power Chuck – 2/3 Jaw Combination

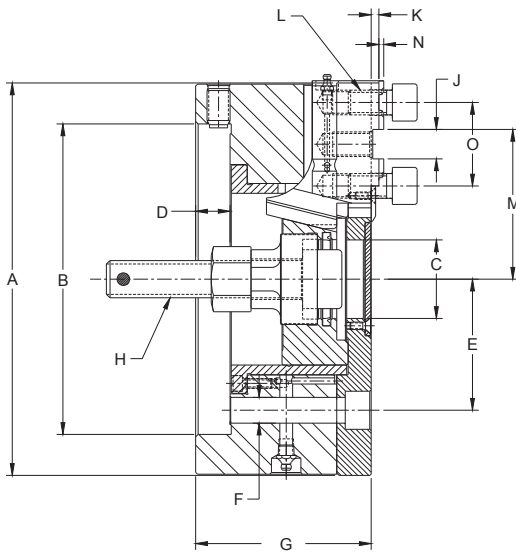
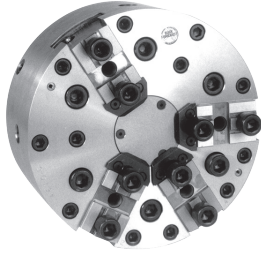

FEATURES AND BENEFITS:

- Ajust-Tru® Precision! Dead-zero precision mounting features for “near-zero” runout
- Holds both round and square parts for greater flexibility and less machine down time
- Extended master jaws bear against front plate to virtually eliminate “bell mouching”
- Wide keyways to increase bearing surfaces, lessen wear and increase stability
- Extremely rugged and precise – designed for easy maintenance
- Hardened and ground steel wear surfaces increase service life
- Guaranteed repeatability of .001" TIR or better on duplicate part production
- Wear plates under master jaws are easily shimmed or replaced to restore original accuracy
- Hardened replaceable wedge bushings available for factory or field replacement; simple grinding restores wedge to original fit
- 4 to 1 mechanical advantage

NOTES:

- Featured with tongue and groove master jaws; other styles available
- Available with or without a Thru Hole
- 2-Jaw, 3-Jaw or 2/3-Jaw styles available
- Parts available for previous models; contact our sales office for more information
- Also available in lightweight aluminum body
- Ajust-Tru® power chuck mounting plate required
- Made in the USA

SUPER LIFE 2/3-JAW COMBINATION POWER CHUCK

Model	A	B	C	D	E	F	G	H	J	K	L	M (max)	M (min)	N	O
A4610	10	7.91	2.00	0.88	3.38	0.69	4.47	1"-14	0.75	0.19	5/8"-11	3.81	3.44	0.13	2.13
A4612	12	7.91	2.00	0.88	3.38	0.69	4.47	1"-14	0.75	0.19	5/8"-11	4.50	4.13	0.13	2.50
A4615	15	11.78	3.19	0.94	4.63	0.78	5.16	1"-14	0.75	0.28	3/4"-10	5.63	5.25	0.13	3.00
A4618	18	11.78	3.19	0.94	4.63	0.78	5.16	1"-14	0.75	0.28	3/4"-10	5.63	5.25	0.13	3.00
A4621	21	16.03	3.75	1.19	6.50	0.94	6.50	1"-14	0.75	0.31	3/4"-10	7.13	6.63	0.13	3.00
A4624	24	16.03	3.75	1.19	6.50	0.94	6.50	1"-14	0.75	0.31	3/4"-10	7.13	6.63	0.13	3.00

SUPER LIFE 2/3-JAW COMBINATION POWER CHUCK

Model	Jaw Travel	Max Drawbar Force (kg)	Wedge Travel	Max RPM	Weight (lb.)
A4610	0.38	9000	1.5	2600	92
A4612	0.38	10500	1.5	2200	133
A4615	0.38	15000	1.5	1500	218
A4618	0.38	15000	1.5	1200	331
A4621	0.50	15000	2.0	1000	570
A4624	0.50	15000	2.0	900	748

Note: Actuation Packages may be needed. Please contact our sales office for more information.

Measurements in inches unless otherwise indicated.

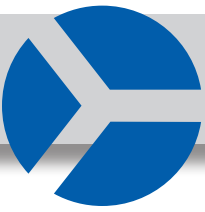

Buck Pull-Back 2-Jaw Power Chuck

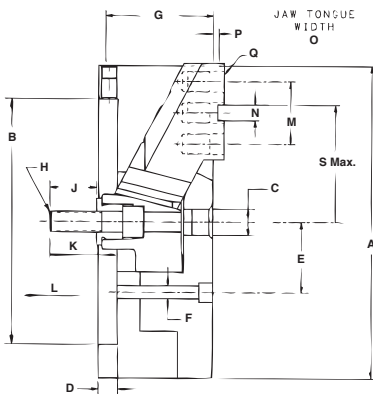

FEATURES AND BENEFITS:

- Adjust-Tru® Precision! Dead-zero precision mounting features for “near-zero” runout
- 100% more gripping power than conventional chucks
- Perfect match for single or multiple spindle machines making heavy cuts on precision work
- Angular jaws on wider keyway plus heavy-duty wedge offer strength and rigidity for maximizing gripping power from beginning to end of jaw travel
- Provides positive end location of parts by holding work solidly against work stops

NOTES:

- **Also available in 3-Jaw**
- Parts available for previous models; contact our sales office for more info
- Adjust-Tru® power chuck mounting plate required
- Made in USA

2-JAW PULL-BACK POWER CHUCK

Part #	Chuck Size	A	B	C	D	E	F	G	H	J	K	L	M	N	O	P MIN	P MAX
3806	6	6.50	4.78	0.75	0.63	2.06	0.469	3.06	.625"-18	1.25	2.25	1.13	1.50	0.50	0.31	0.31	0.16
3808	8	8.25	6.16	0.88	0.66	2.63	0.530	3.75	.625"-18	1.75	2.53	1.28	1.75	0.50	—	0.31	0.16
3810	10	10.00	7.91	0.88	0.88	2.63	0.530	4.72	1"-14	2.66	3.69	1.69	2.13	0.75	—	0.34	0.16
3812	12	12.00	7.91	0.88	0.88	3.38	0.660	5.13	1"-14	2.66	3.69	1.69	2.50	0.75	—	0.38	0.19
3815	15	15.00	11.78	1.25	0.94	4.63	0.780	5.50	1"-14	2.25	3.19	1.69	3.00	0.75	—	0.58	0.38
3818	18	18.00	11.78	1.25	0.94	4.63	0.780	6.00	1"-14	1.50	2.69	1.69	3.00	0.75	—	0.58	0.31
3821	21	21.00	16.03	2.00	1.19	6.50	0.940	7.94	1"-14	1.75	4.00	2.28	3.00	0.75	—	0.58	0.31
3824	24	24.00	16.03	2.00	1.19	6.50	0.940	7.94	1"-14	1.75	4.00	2.28	3.00	0.75	—	0.58	0.31

SPECIFICATIONS CONTINUED

Part #	Q	R	S MAX	Jaw Travel (in.)	Wedge Travel (in.)	Max. Drawbar Force (kg)	Max. RPM	Weight (lb.)
3806	.437"-14	1	2.44	0.25	1.13	6000	3000	26
3808	.750"-16	1	3.06	0.28	1.28	10000	2500	55
3810	.875"-14	1	3.81	0.38	1.69	15000	2000	92
3812	.875"-14	1	4.50	0.38	1.69	18000	1700	133
3815	1"-14	1	5.63	0.38	1.69	25000	1400	218
3818	1"-14	2	5.63	0.38	1.69	25000	1100	331
3821	1"-14	2	7.13	0.50	2.28	25000	1080	570
3824	1"-14	3	7.13	0.50	2.28	25000	900	748

Note: Actuation Packages may be needed. Please contact our sales office for more information. Measurements in inches unless otherwise indicated.

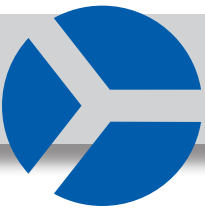

Buck Extra Heavy-Duty Oil Country Chucks

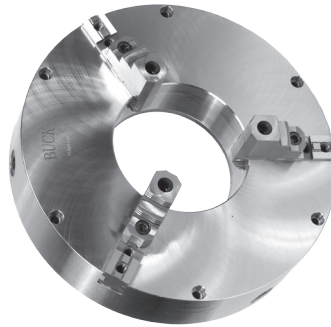

Buck Chuck offers a wide variety of heavy duty oil country chucks. Below are the most standard offerings. However, if you don't see what you are looking for here, please let us know. We can provide chucks up to 80", both manual and power operated.

3 JAW HEAVY DUTY OIL COUNTRY SCROLL CHUCKS

Chuck Dia. (in)	Spindle Mount	Thru-Hole	Max RPM	Clamp Range (in)	Grip Force (lbf)	Weight (lbs)	Load Capacity (lb)
20"	A2-11	7.50	1000	1.77-19.68	16300	560	5200
20"	A2-15	8.00	1000	1.77-19.68	16300	560	5200
25"	A2-15	10.50	850	3.15-24.50	18040	630	7800
25"	A2-20	12.50	850	6.30-24.80	18040	630	7800
32"	A2-15	10.50	600	5.12-31.50	19140	1200	10400
32"	A2-20	12.50	600	7.09-31.50	19140	1200	10400

4 JAW HEAVY DUTY OIL COUNTRY INDEPENDENT CHUCKS

Chuck Dia. (in)	Spindle Mount	Thru-Hole	Max RPM	Clamp Range (in)	Grip Force (lbf)	Weight (lbs)	Load Capacity (lb)
20"	A2-11	6.50	1000	1.77-19.68	7057	450	9900
20"	A2-15	8.00	1000	1.77-19.68	7057	450	9900
25"	A2-15	10.50	850	1.97-24.80	8160	630	14300
25"	A2-20	12.50	850	3.94-24.80	8160	630	14300
32"	A2-15	10.50	600	5.12-31.50	9040	1287	18700
32"	A2-20	12.50	600	7.09-31.50	9040	1287	18700

LARGER SIZES AND ALTERNATE MOUNTS AVAILABLE- PLEASE CONTACT OUR SALE OFFICE FOR MORE INFORMATION 1-800-228-BUCK INFO@BUCKCHUCK.COM

**Buck Chuck Company is your workholding solution.
If there is something you need that is not featured here, please
contact us. We may be able to help.**

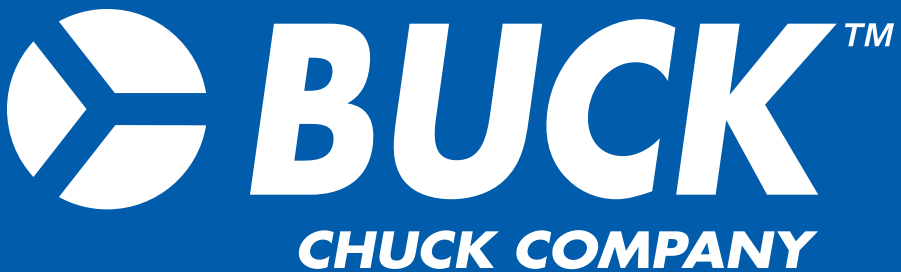

Tel: 800-228-BUCK
Fax: 607-398-7998
www.BuckChuck.com
info@BuckChuck.com

BC 2015 V. 1